

0	1	2	3	4	5	6	7	8	9
	GEN SET	TOROIDE TRAF. O.	CURRENT TRANSF.		GEN SET VOLT.	AUX POWER	GEN SET CIRCUIT BREAKER		
								LOAD	TRIP COIL
MOUNTED ON THIS GEN SET									
	ALTERNATOR PHASE X								
	ALTERNATOR PHASE Y								
	ALTERNATOR PHASE Z								
	ALTERNATOR N								
	PROTECTIVE EARTH								
	MEASUREMENT								
	-								
			PHASE X						
			PHASE Y						
			PHASE Z						
			COMMON						
					PHASE X FUSE				
					PHASE Y FUSE				
					PHASE Z FUSE				
					GEN SET N				
					PROTECTIVE EARTH				
						PHASE U			
						PHASE V			
						PHASE W			
						N. LOAD			
						PROTECTIVE EARTH			
						BREAKER POS. IND. 1 NO, 'INC			
						PHASE X			
						PHASE Y			
						PHASE Z			
						GEN SET N			
						PROTECTIVE EARTH			
						BREAKER POS. IND. 230V AC			
						TRIP COIL			
						N. TO COMMAND			

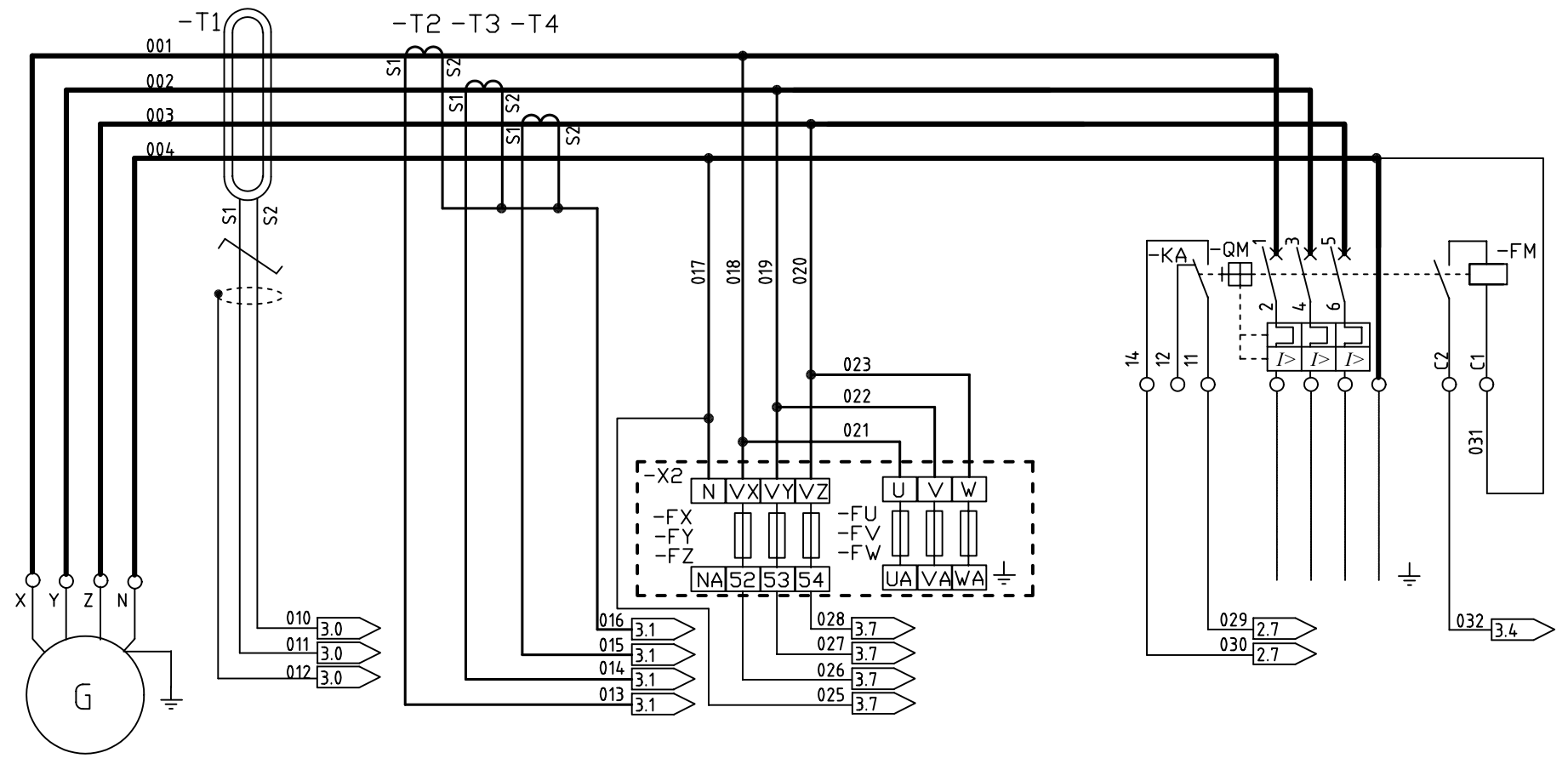

0		1		2		3		4		5		6		7		8		9									
GEN SET CONTROL AND SAFETY												REMOTE CONTROL		BATT. CHARG.		MCB & CONTACT. IND.		FUEL P. & PREHEAT C.									
		OPTION				OPTION				OPTION								OPTION									
MOUNTED ON THIS GEN SET																											
+ BATTERY	- BATTERY	CONNECT TERMINAL 3 AND 4 FOR POWER SUPPLY 12 VDC		EXT. ALARM	START	STOP SOLENOID	FUEL SOLENOID	EXT. ALARM RELAY	LOW OIL PRESSURE	CHARGE ALTERNATOR D+	HIGH WATER TEMPERATURE	HIGH OIL TEMPERATURE	LOW FUEL LEVEL	LOW WATER LEVEL (STD. DEUTZ 1012 & 1015 >)	FUEL LEVEL	COOLANT TEMPERATURE	OIL PRESSURE	EJP	EXT. EMERGENCY STOP	REMOTE CONTROL 1=BLOCK,0=AUTO,2=START	BATTERY CHARGER	TRIPPED CIRCUITBREAKER	MAINS CONTACTOR ON	GEN SET CONTACTOR ON	B-	FUEL PUMP CONTROL	PRE HEATING CONTROL

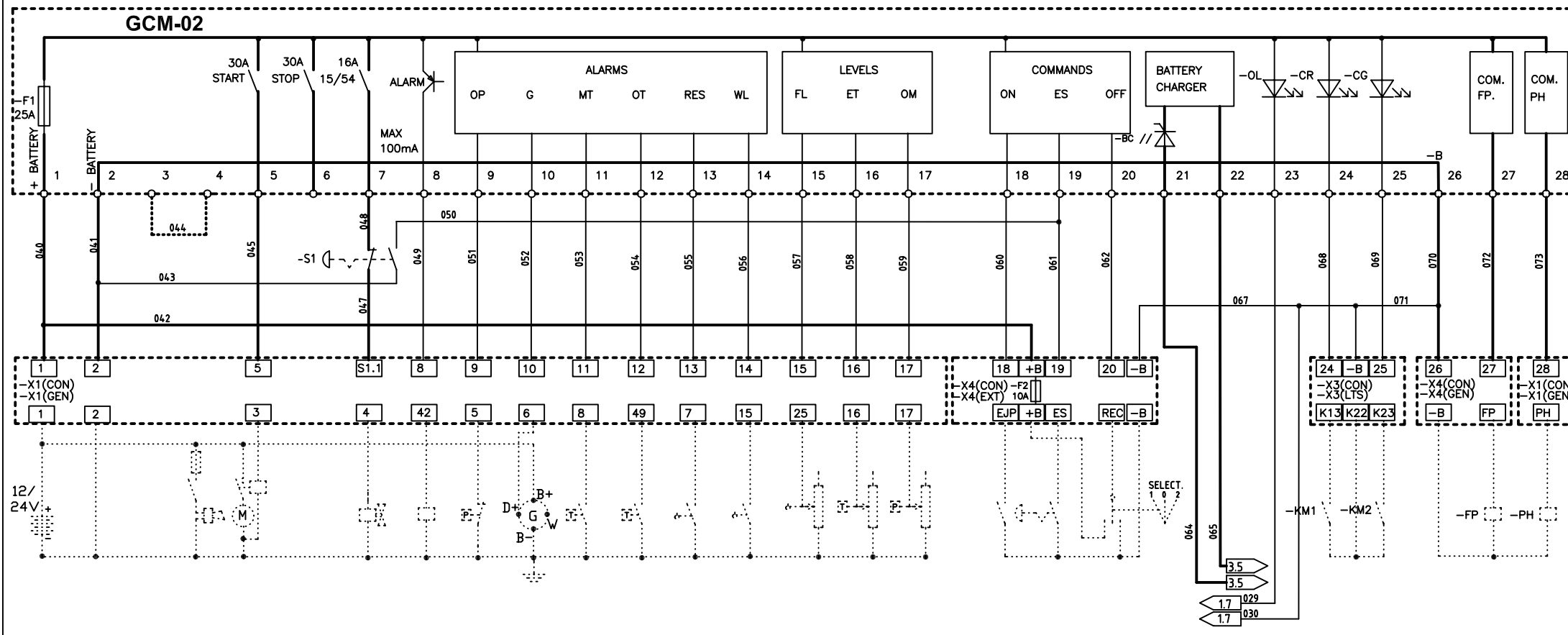

ACP ENGINE CONTROL & AUXILIARIES

N.- ACP1G-2
 Dib: Hakan Ericsson/JASP

Pag: 2
 Fecha: 03/03/03

0	1	2	3	4	5	6	7	8	9															
DIFFERENTIAL PROT. RELAY		CURRENT MEASUREMENT		MAINS CONTACTOR		MCB TRIP	GEN SET CONTACTOR	BATT CHARG.	MAINS VOLTAGE		GEN SET VOLTAGE													
				OPTION			OPTION																	
MOUNTED ON THIS GEN SET																								
MEASUREMENT		-	TEST	-	PHASE U	PHASE V	PHASE W	COM.	PHASE R	NORMALLY OPEN	NORMALLY CLOSED	CIRCUIT BREAKER TRIP	PHASE X	OPEN	CLOSE	BATTERY CHARGER INPUT 230 V AC	NEUTRAL	PHASE R	PHASE S	PHASE T	NEUTRAL	PHASE X	PHASE Y	PHASE Z

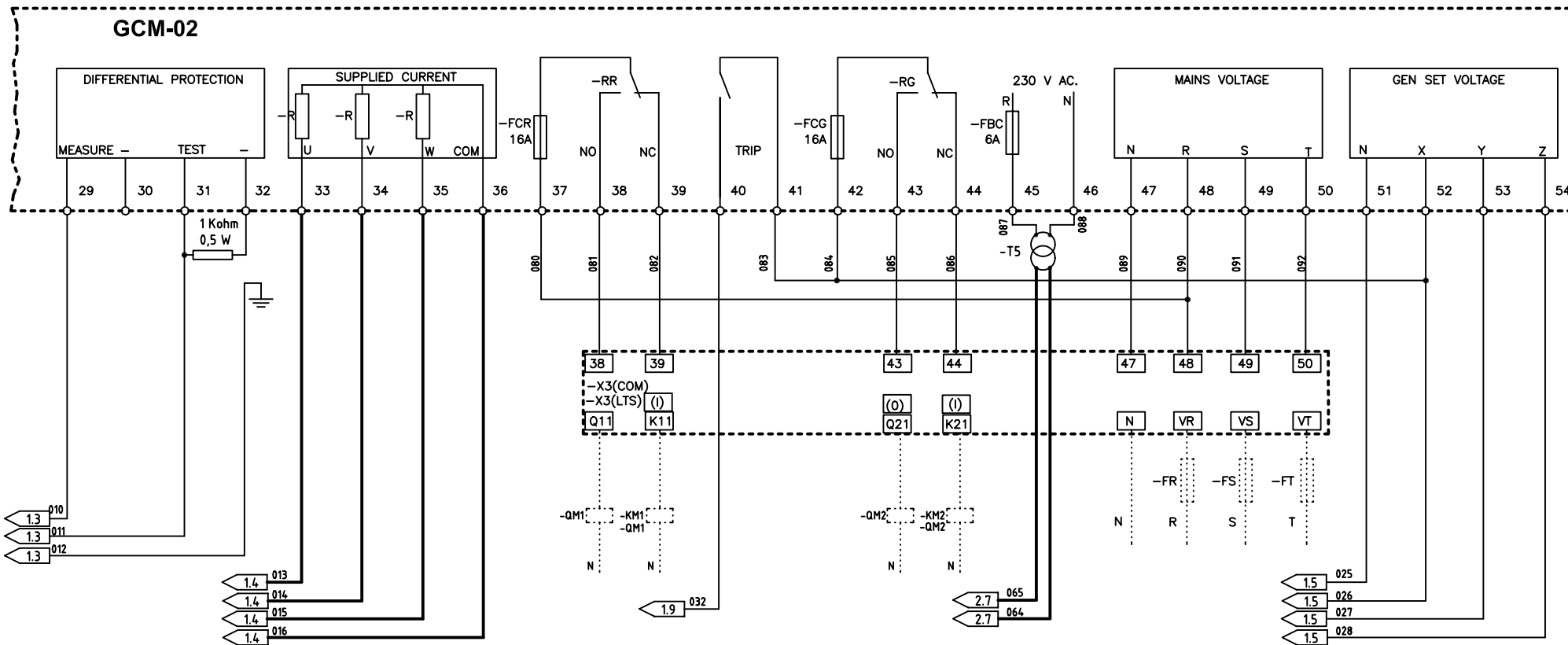

VISTA INTERIOR

VISTA EXTERIOR

BORNERO

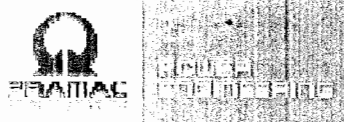
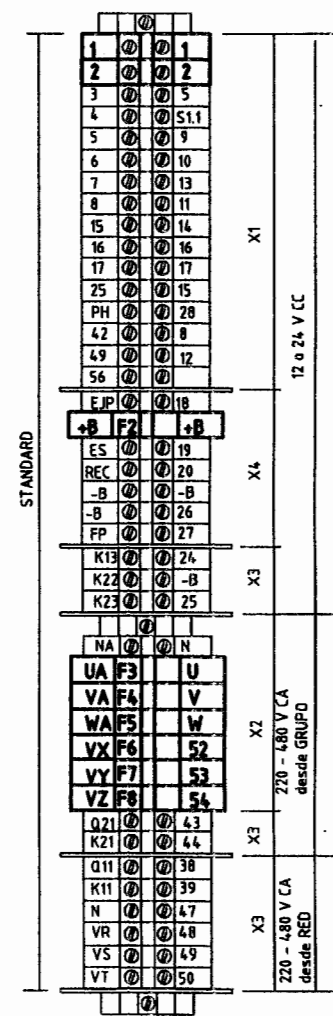
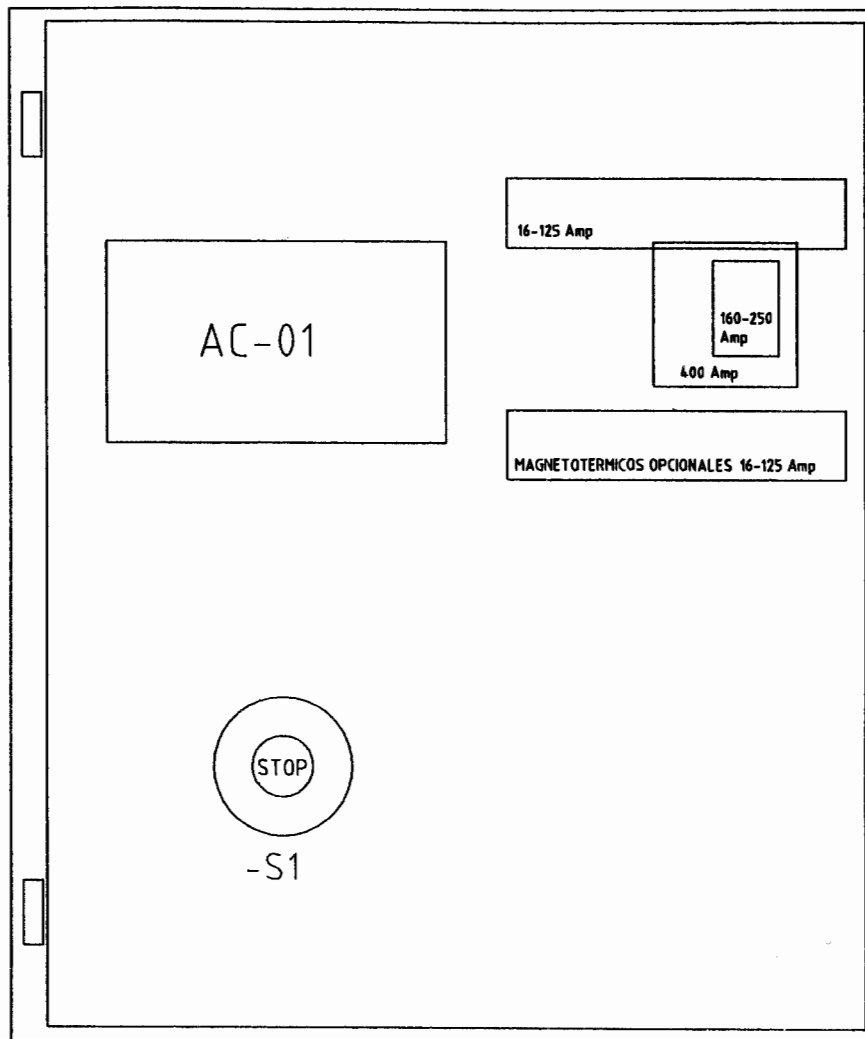
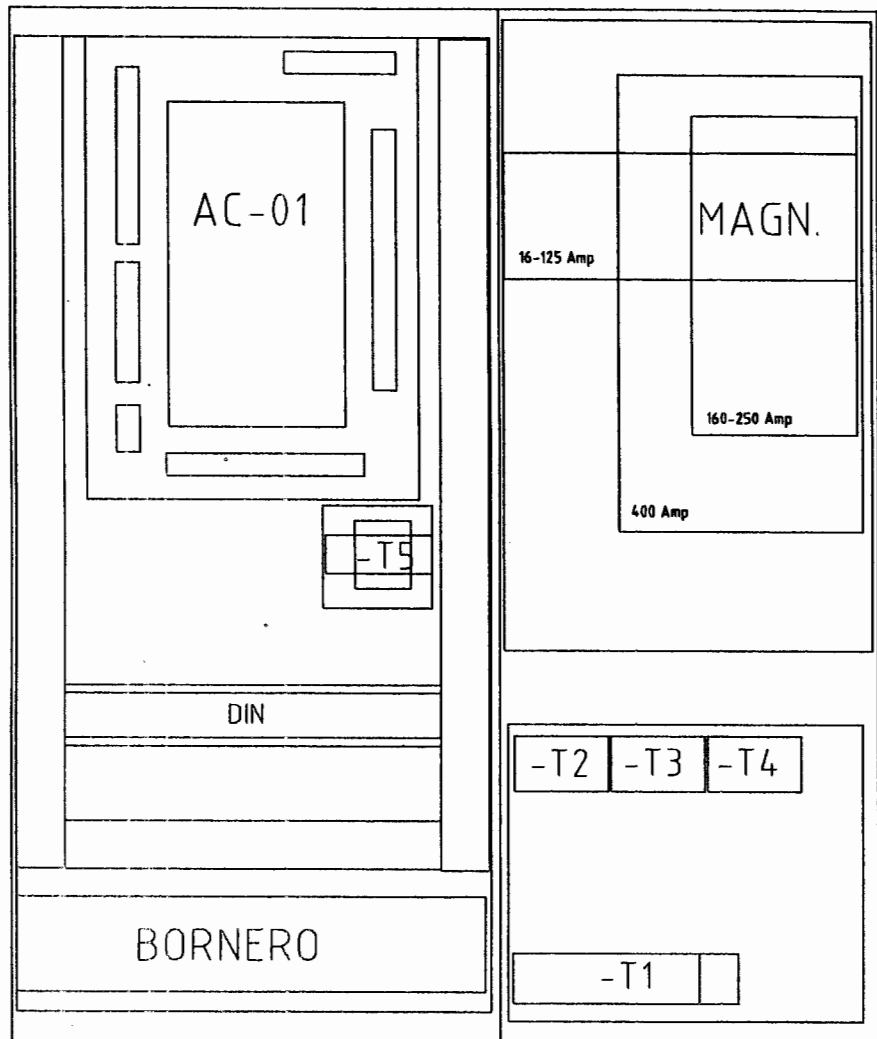

0	1	2	3	4	5	6	7	8	9																								
	LOAD	MAINS CONTACTOR			MAINS VOLTAGE	GENSET CONTACTOR			AUX. POWER																								
MOUNTED ON THIS GEN SET																																	
	PLINTH PHASE U	PLINTH PHASE V	PLINTH PHASE W	PLINTH N LOAD	PROTECTIVE EARTH	CONTACTOR POSITION SWITCH	ELECTRIC INTERLOCK	CONTACTOR POSITION IND.	CONTACTOR COIL	PHASE R	PHASE S	PHASE T	N MAINS	PROTECTIVE EARTH	PHASE R FUSE	PHASE S FUSE	PHASE T FUSE	N MAINS	MECHANICAL INTERLOCK	CONTACTOR POSITION SWITCH	ELECTRIC INTERLOCK	CONTACTOR POSITION IND.	CONTACTOR COIL	PHASE X	PHASE Y	PHASE Z	N GENSET	PROTECTIVE EARTH	PHASE U	PHASE V	PHASE W	N LOAD	PROTECTIVE EARTH

