

Electrical Characteristics										
Frequency	Hz	50				60				
Voltage (star)	V	380	400	415	440	415	440	460	480	
Rated power class H	kVA	22	22	22	19	22	25	26,5	26,5	
	kW	17,6	17,6	17,6	15,2	17,6	20	21,2	21,2	
Rated power class F	kVA	20	20	20	17	20	23	24	24	
	kW	16	16	16	13,6	16	18,4	19,2	19,2	
Regulation with SR7/2		±1,5 % with any power factor and speed variations between -5% +30%								
Insulation class		H								
Execution		Brushless								
Stator winding		12 ends								
Rotor		with damping cage								
Efficiencies class H	4/4	%	85,1	85,2	84,9	84,7	85,5	86	86,1	86,2
(see graph. for details)	3/4	%	85,5	85,8	85,7	85,4	86,5	86,7	86,9	87,1
	2/4	%	83,4	83,5	83,5	83,2	84,7	84,8	84,9	85
	1/4	%	80,1	80	79,8	79,3	80,8	80,6	80,7	81
Reactances (f. l.cl. F)	Xd	%	227,9	205,7	191,1	146,8	228,5	230,9	224,0	206
	Xd'	%	8,64	7,8	7,25	5,57	8,66	8,76	8,49	7,8
	Xd''	%	5,21	4,7	4,37	3,35	5,22	5,28	5,12	4,7
	Xq	%	130,7	118	109,6	84,2	131,1	132,5	128,5	118
	Xq'	%	130,7	118	109,6	84,2	131,1	132,5	128,5	118
	Xq''	%	30,1	27,2	25,3	19,4	30,2	30,5	29,6	27,2
	X ₂	%	15,29	13,8	12,82	9,85	15,33	15,49	15,03	13,8
	X ₀	%	6,76	6,1	5,67	4,35	6,77	6,85	6,64	6,1
Short Circuit Ratio	Kcc		0,98	1,1	1,31	1,50	0,85	0,93	0,98	1,1
Time Constants	Td'	sec.	0,039							
	Td''	sec.	0,011							
	Tdo'	sec.	0,68							
	Tα	sec.	0,027							
Short Circuit Current Capacity		%	>300				>320			
Excitation at no load	Amp.		0,48	0,53	0,6	0,8	0,35	0,4	0,45	0,5
Excitation at full load	Amp.		1,3	1,4	1,6	1,6	1,1	1,1	1,2	1,3
Overload (long-term)		%	1 hour in a 6 hours period 110% rated load							
Overload per 20 sec.		%	300							
Stator Winding Resistance (20°C)	Ω		0,148							
Rotor Winding Resistance (20°C)	Ω		4,877							
Exciter Resistance (20 °C)	Ω		Rotor : 0,640				Stator : 10,60			
Heat dissipation at f.l.cl.H	W		3082	3057	3130	2746	2985	3256	3423	3394
Telephone Interference			THF < 2%				TIF < 45			
Radio interference			EN50081-1, EN50082-1, VDE0875K. For others standards apply to factory							
Waveform Distors.(THD) at f. load	LL/LN %		2,4 / 3,7							
Waveform Distors.(THD) at no load	LL/LN %		2,9 / 4,5							
Mechanical characteristics										
Protection			IP 23 (other protection on request)							
DE bearing			6309-2RS							
NDE bearing			6209-2RS							
Weight of wound stator assembly	kg		39,6							
Weight of wound rotor assembly	kg		21,5							
Weight of complete generator	kg		129							
Maximun overspeed	rpm		4500							
Unbalanced magnetic pull at f.l.cl.F	kN/mm		3,2							
Cooling air requirement	m³/min		9,7				11			
Inertia Constant (H)	sec.		0,206				0,247			
Noise level at 1m/7m	dB(A)		86 / 74				90,5 / 78			

50 Hz

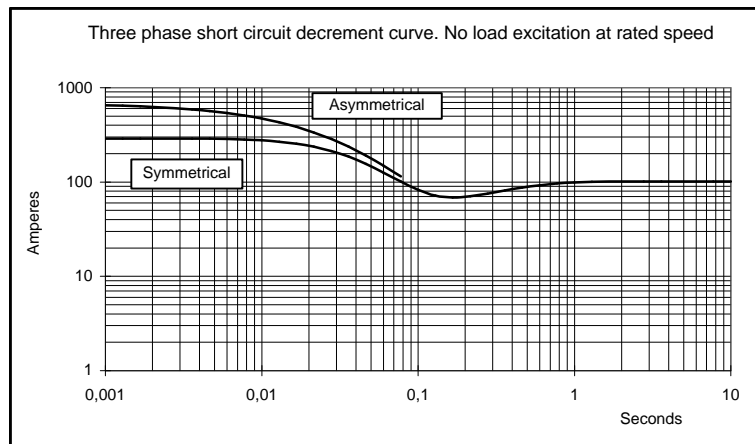

60 Hz

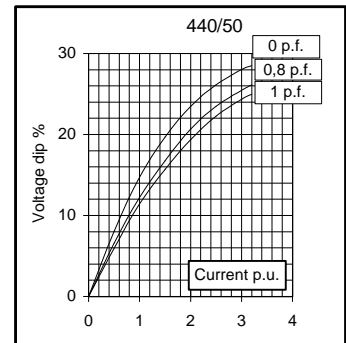
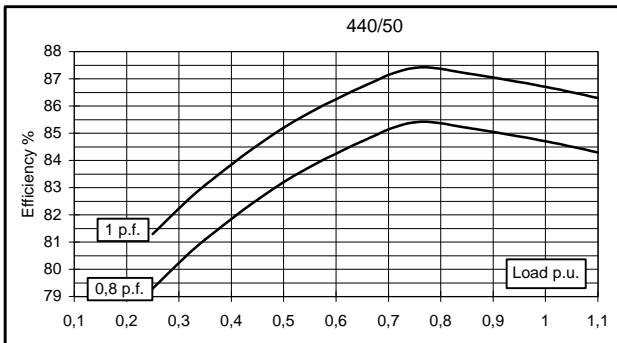
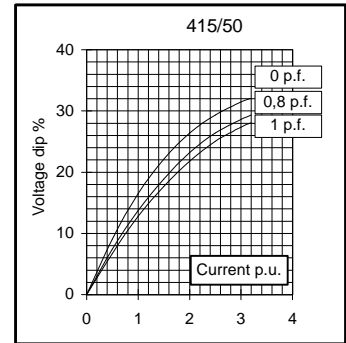
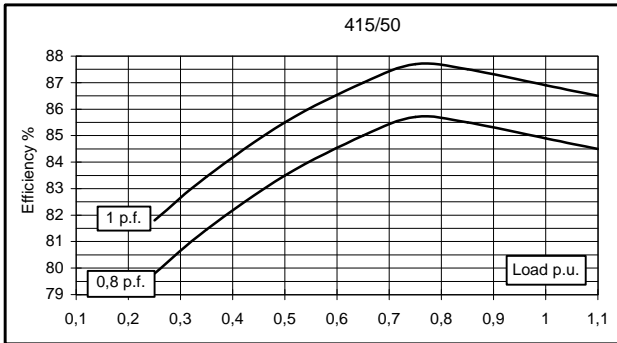
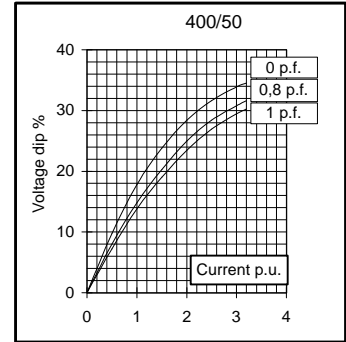
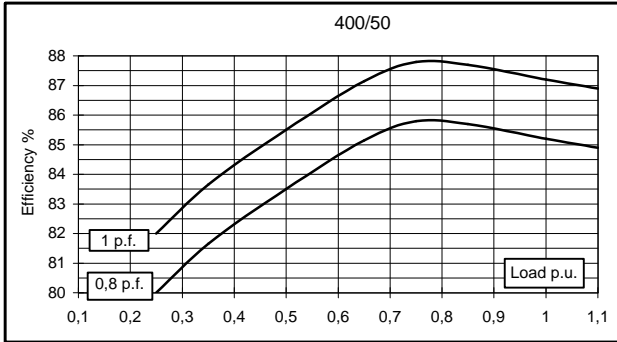
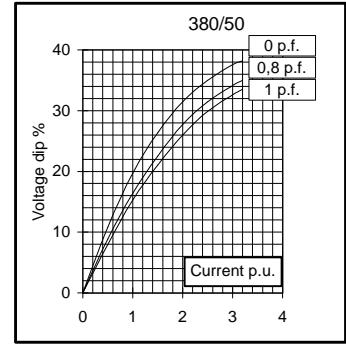
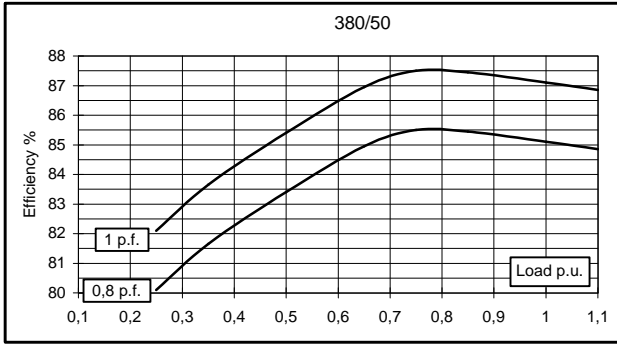
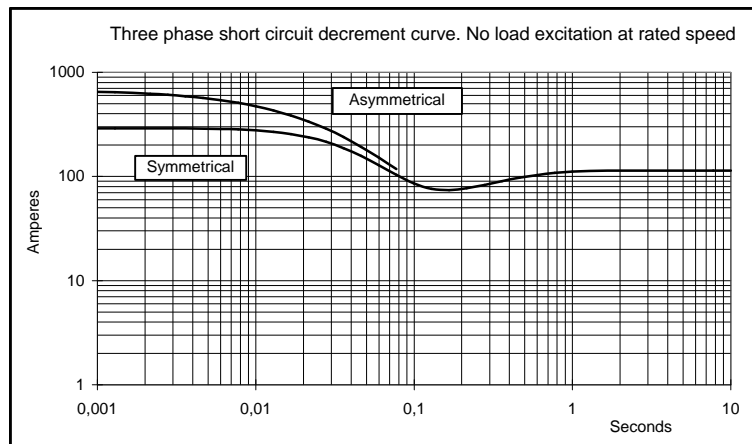
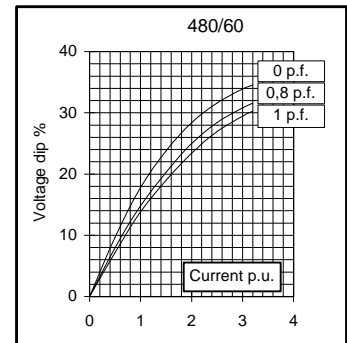
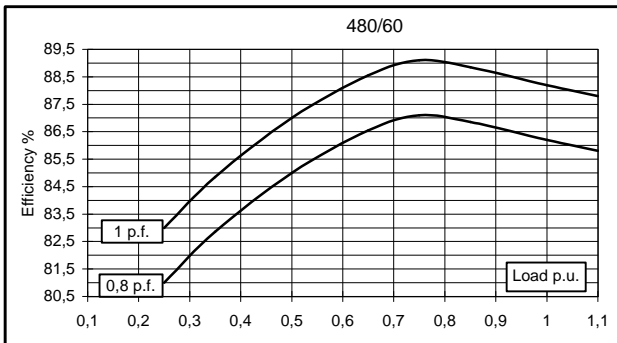
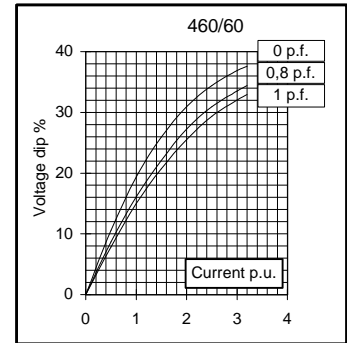
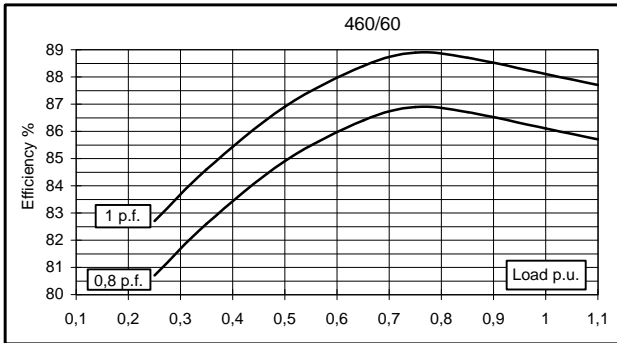
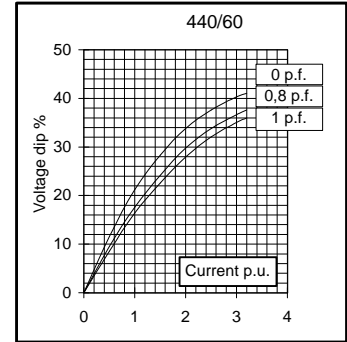
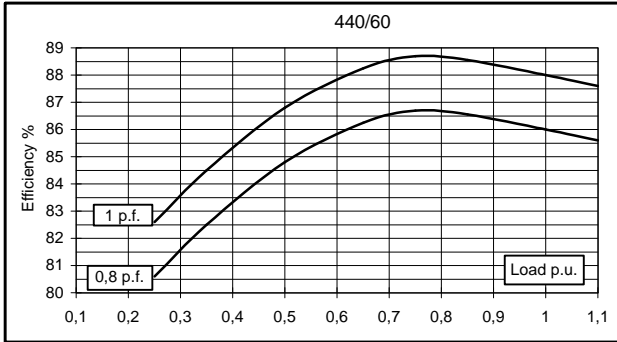
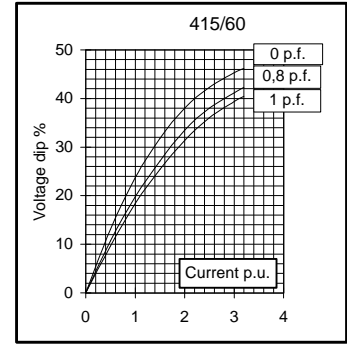
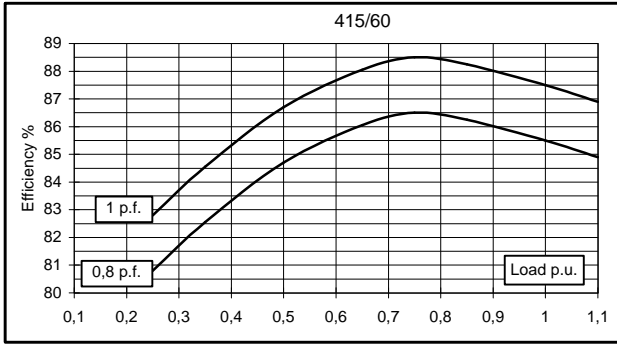

TWO BEARING MOMENTS OF INERTIA

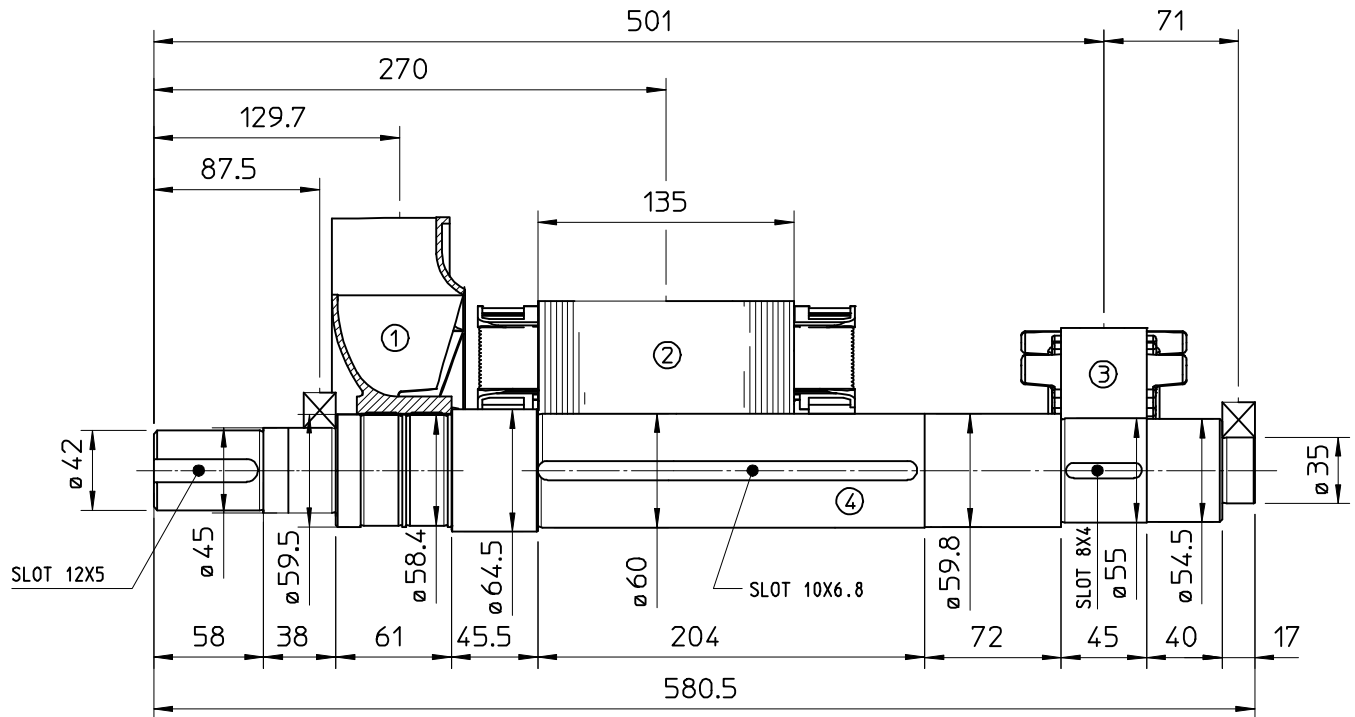

COMPONENT	WEIGHT Kg	J Kg ²
1 FAN	1.2	0.0102
2 MAIN ROTOR	18.5	0.065
3 EX ROTOR	5.4	0.012
4 SHAFT	10.7	0.0045
6 TOTAL	35.8	0.0917

TWO BEARING DIMENSIONS

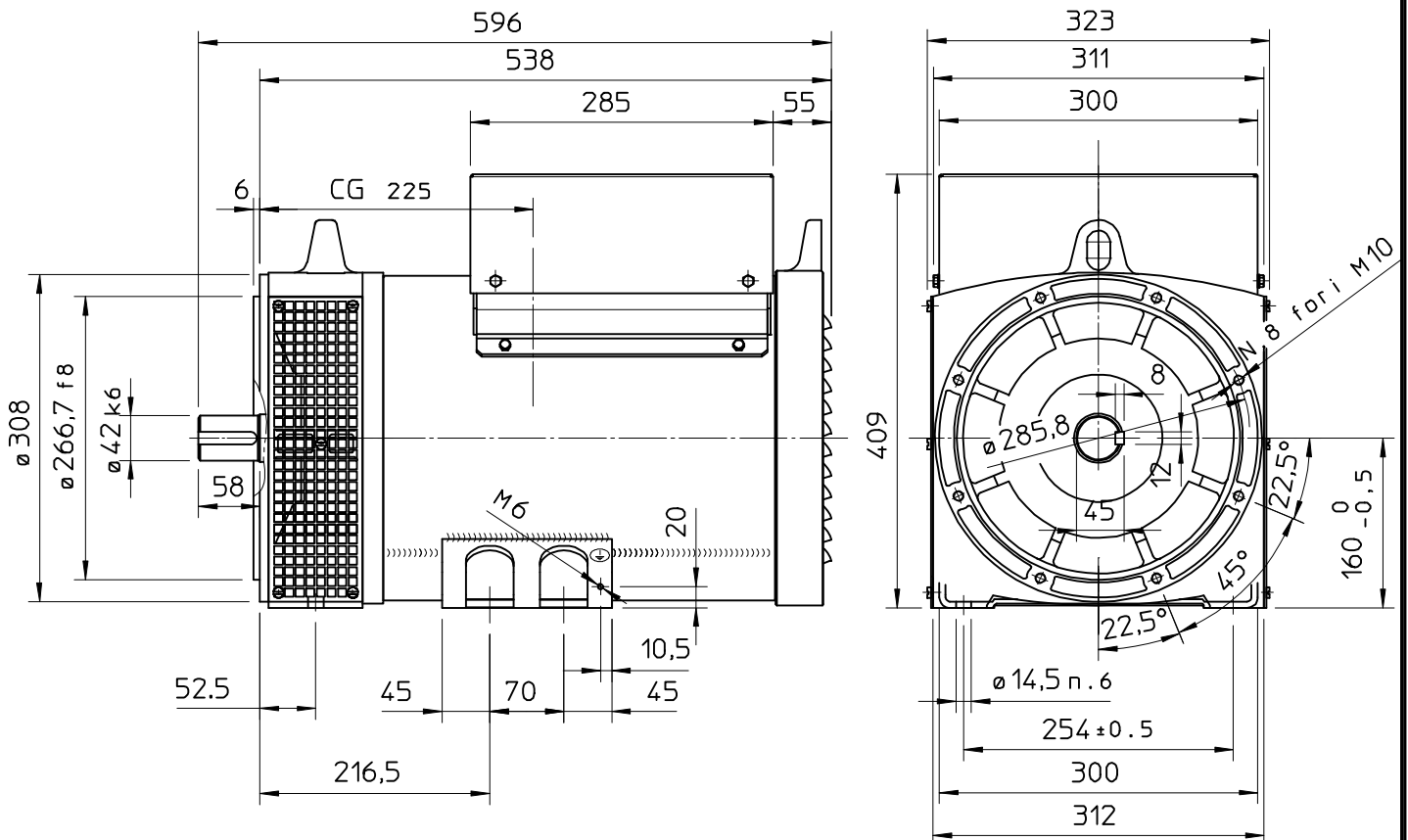

SINGLE BEARING MOMENTS OF INERTIA

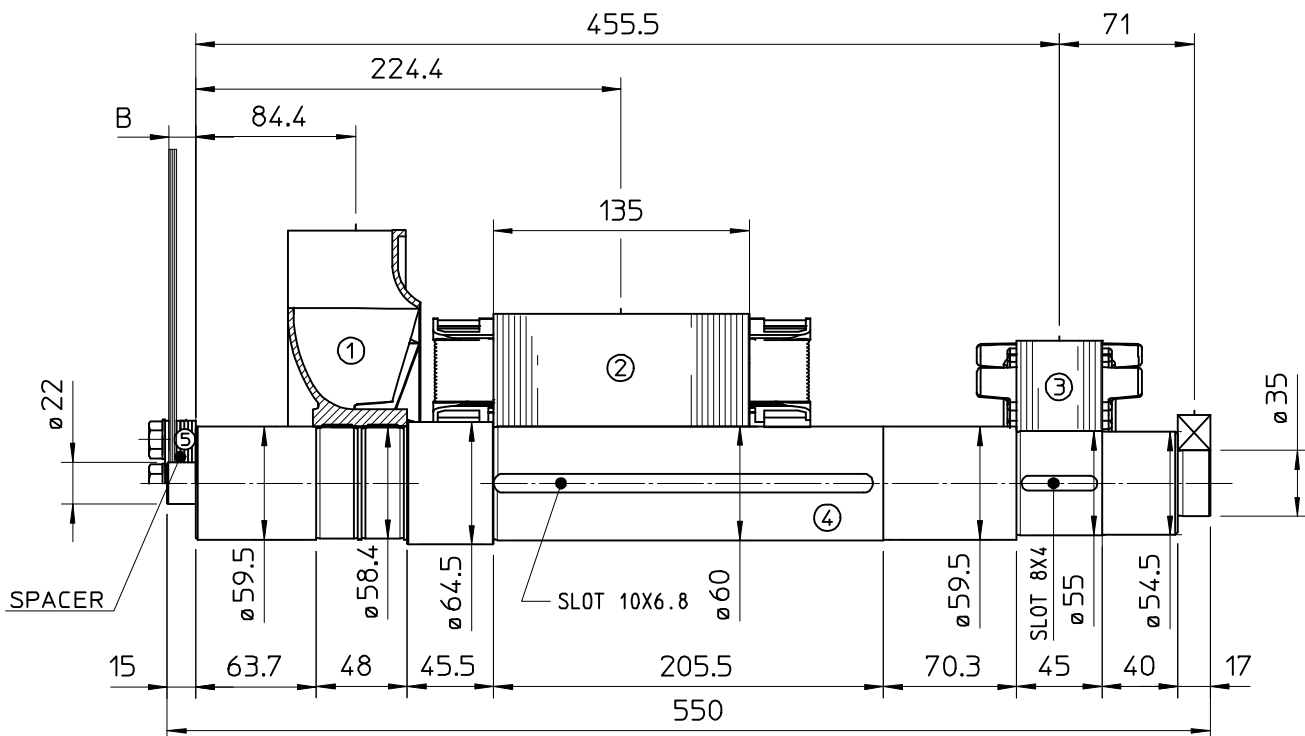

COMPONENT	WEIGHT Kg	J Kg ²
1 FAN	1.2	0.0102
2 MAIN ROTOR	18.5	0.065
3 EX ROTOR	5.4	0.012
4 SHAFT	10.6	0.0044
6 TOTAL	35.7	0.0916

SAE N.	5	SHAFT COUPLING FLEX PLATE	
	B (mm)	WEIGHT kg	J kgm ²
6 1/2	4	1.14	0.0067
7 1/2	4	1.42	0.0103
8	35.6	1.97	0.0171
10	27.6	2.59	0.0319
11 1/2	14	3.1	0.0481

SINGLE BEARING DIMENSIONS

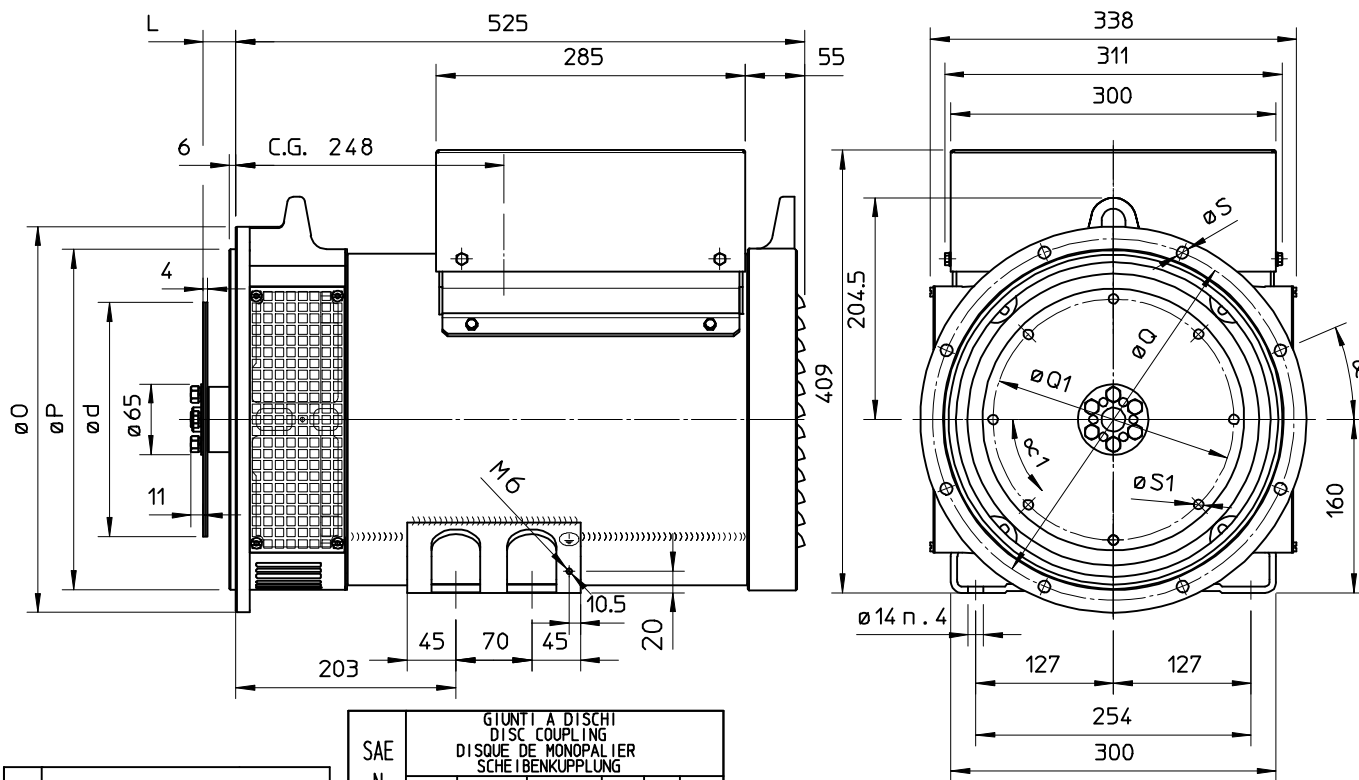

SAE N.	FLANGIA/FLANGE BRIDE/FLANSCH					
	O	P	Q	n. for i	S	α
5	356	314.3	333.4	8	11	22°30'
4	403	362	381	12	11	15°
3	451	409.6	428.6	12	11	15°

SAE N.	GIUNTI A DISCHI DISC COUPLING DISQUE DE MONDPALEIER SCHEIBENKUPPLUNG						
	L	d	Q1	n. for i	S1	α1	
6 1/2	30.2	215.9	200	6	9	60°	
7 1/2	30.2	241.3	222.25	8	9	45°	
8	62	263.52	244.47	6	11	60°	
10	53.8	314.32	295.27	8	11	45°	
11 1/2	39.6	352.42	333.37	8	11	45°	

C.G. = GRAVITY CENTER