

Electrical Characteristics										
Frequency	Hz	50				60				
Voltage (star)	V	380	400	415	440	415	440	460	480	
Rated power class H	kVA	27	27	27	23	27	31	32,5	32,5	
	kW	21,6	21,6	21,6	18,4	21,6	24,8	26	26	
Rated power class F	kVA	25	25	25	21	24,5	28,5	30	30	
	kW	20	20	20	16,8	19,6	22,8	24	24	
Regulation with	SR7/2	±1,5 % with any power factor and speed variations between -5% +30%								
Insulation class		H								
Execution		Brushless								
Stator winding		12 ends								
Rotor		with damping cage								
Efficiencies class H	4/4	%	86,3	86,4	86,1	85,9	87,2	87,7	87,8	87,9
(see graph. for details)	3/4	%	86,7	87	86,7	86,6	88,2	88,4	88,6	88,8
	2/4	%	84,7	84,8	84,8	84,7	86,5	86,6	86,7	86,8
	1/4	%	81,1	81	80,8	80,3	82,1	82,1	82,1	82
Reactances (f. l.cl. F)	Xd	%	248,4	224,2	208,3	157,8	249,2	254,5	244,1	224
	Xd'	%	8,42	7,6	7,06	5,35	8,45	8,63	8,28	7,6
	Xd''	%	4,76	4,3	3,99	3,03	4,78	4,88	4,68	4,3
	Xq	%	135,2	122	113,3	85,9	135,6	138,5	132,8	122
	Xq'	%	135,2	122	113,3	85,9	135,6	138,5	132,8	122
	Xq''	%	26,7	24,1	22,4	17,0	26,8	27,4	26,2	24,1
	X ₂	%	14,52	13,1	12,17	9,22	14,56	14,87	14,26	13,1
	X ₀	%	5,76	5,2	4,83	3,66	5,78	5,90	5,66	5,2
Short Circuit Ratio	Kcc		0,83	0,95	1,17	1,45	0,71	0,78	0,83	0,95
Time Constants	Td'	sec.	0,041							
	Td''	sec.	0,012							
	Tdo'	sec.	0,71							
	Tα	sec.	0,038							
Short Circuit Current Capacity		%	>300				>320			
Excitation at no load	Amp.		0,5	0,55	0,6	0,8	0,35	0,4	0,45	0,5
Excitation at full load	Amp.		1,2	1,27	1,35	1,5	1	1	1,1	1,2
Overload (long-term)		%	1 hour in a 6 hours period 110% rated load							
Overload per 20 sec.		%	300							
Stator Winding Resistance (20°C)	Ω		0,0863							
Rotor Winding Resistance (20°C)	Ω		5,523							
Exciter Resistance (20 °C)	Ω		Rotor : 0,64				Stator : 10,60			
Heat dissipation at f.l.cl.H	W		3429	3400	3487	3020	3171	3478	3613	3579
Telephone Interference			THF < 2%				TIF < 45			
Radio interference			EN50081-1, EN50082-1, VDE0875K. For others standards apply to factory							
Waveform Distors.(THD) at f. load	LL/LN %		2,3 / 2,1							
Waveform Distors.(THD) at no load	LL/LN %		2,8 / 2,5							
Mechanical characteristics										
Protection			IP 23 (other protection on request)							
DE bearing			6309-2RS							
NDE bearing			6209-2RS							
Weight of wound stator assembly	kg		45							
Weight of wound rotor assembly	kg		23,5							
Weight of complete generator	kg		136							
Maximun overspeed	rpm		4500							
Unbalanced magnetic pull at f.l.cl.F	kN/mm		3,5							
Cooling air requirement	m³/min		9,7				11			
Inertia Constant (H)	sec.		0,192				0,230			
Noise level at 1m/7m	dB(A)		86 / 74				90,5 / 78			

All technical data are to be considered as a reference and they can be modified without any notice

This document is a propriety of Mecc Alte S.p.a..All rights reserved.

50 Hz

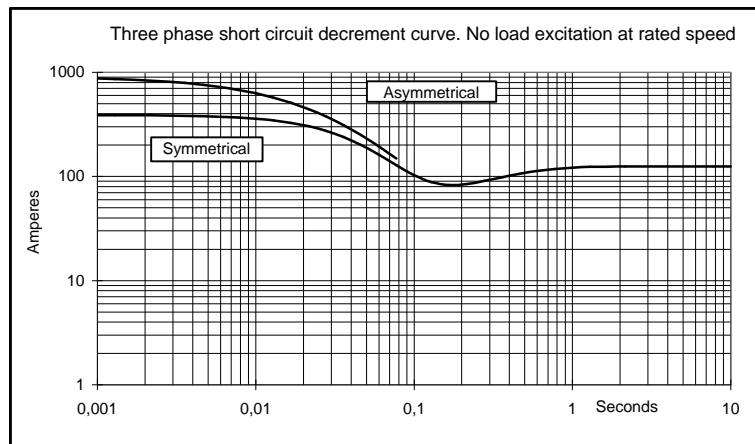
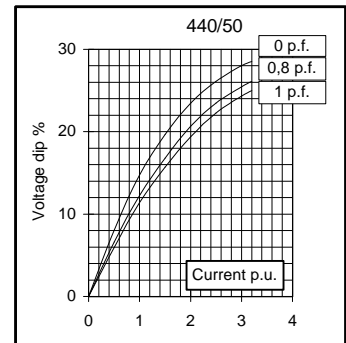
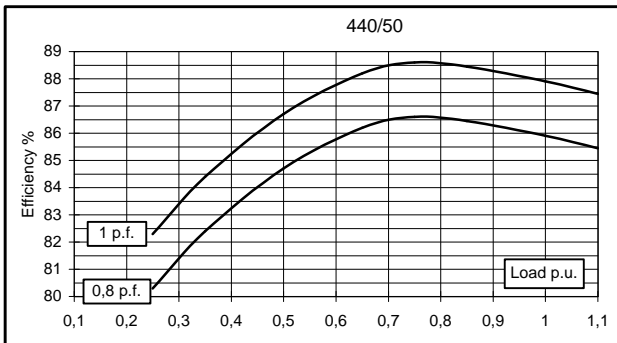
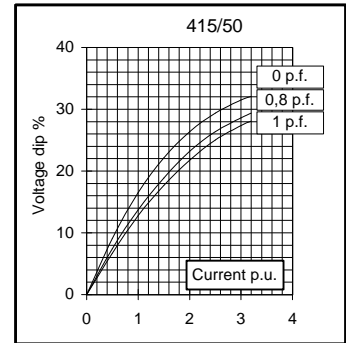
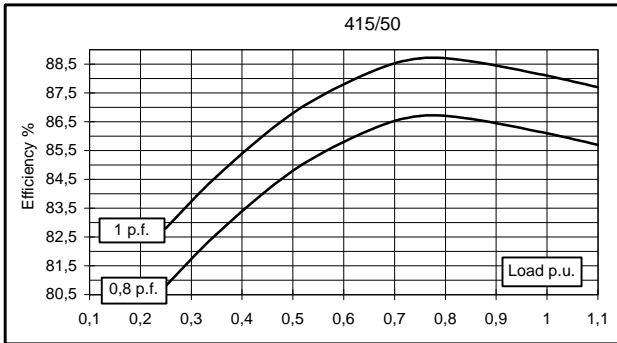
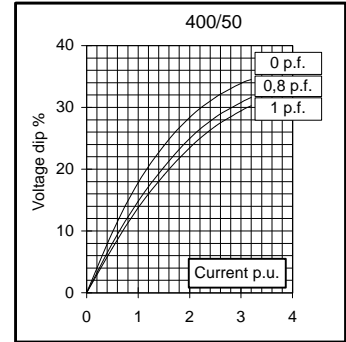
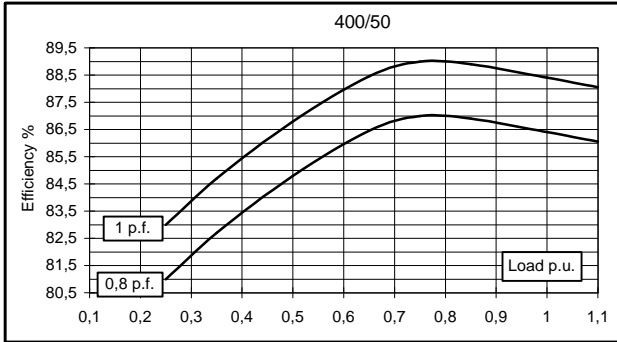
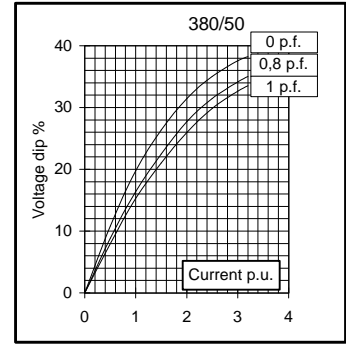
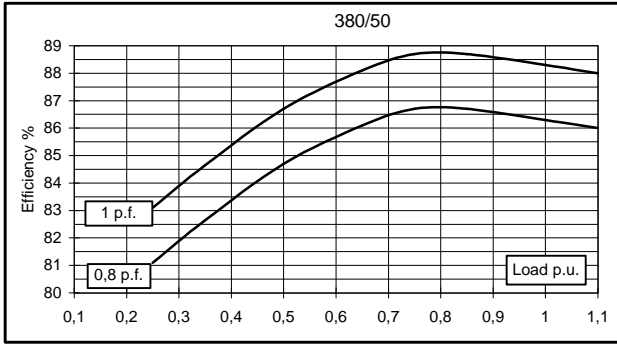

60 Hz

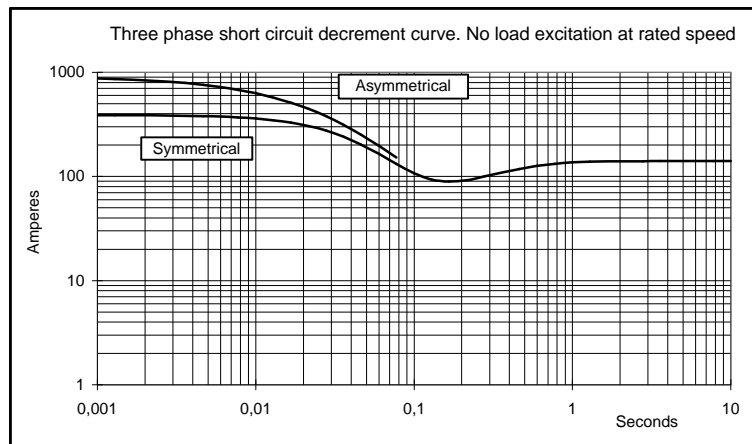
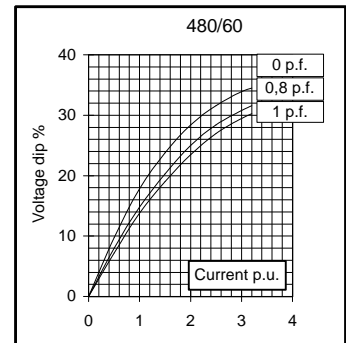
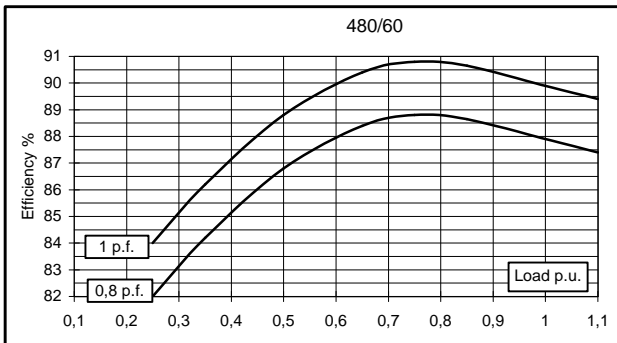
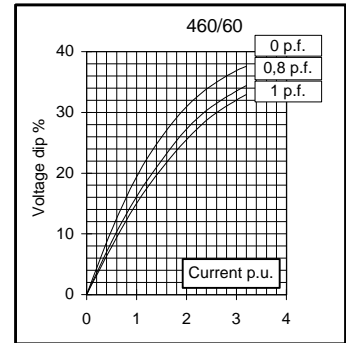
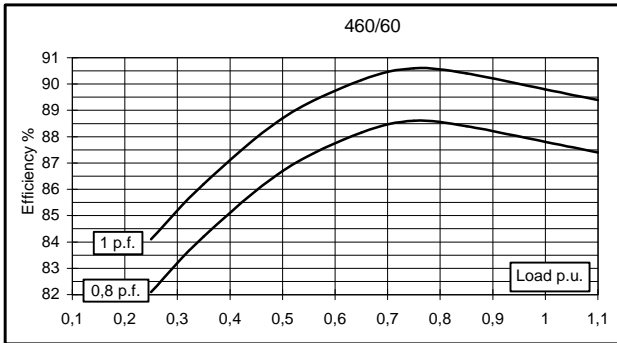
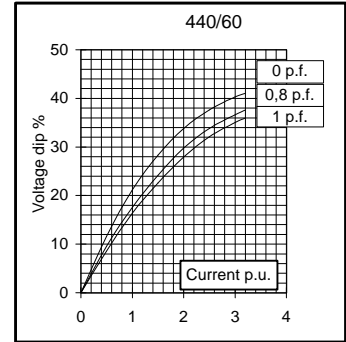
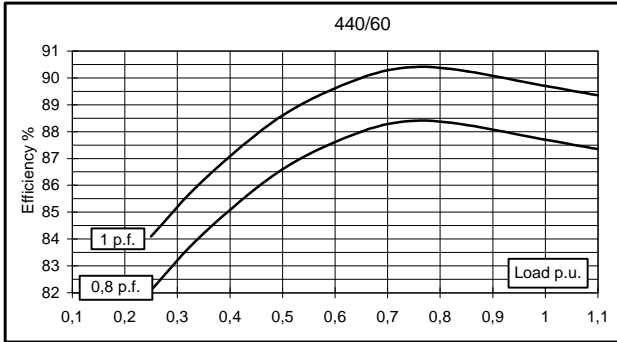
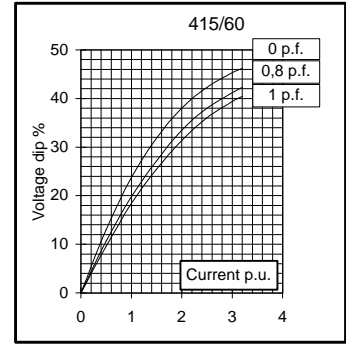
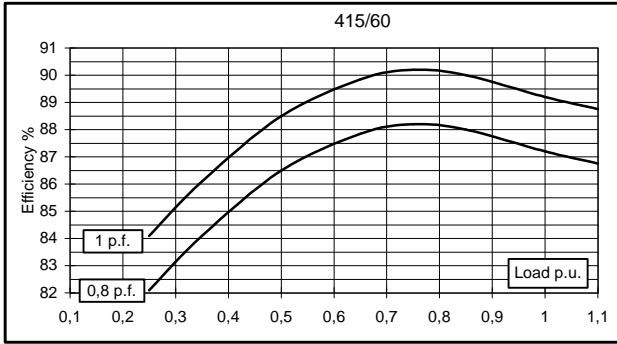

TWO BEARING MOMENTS OF INERTIA

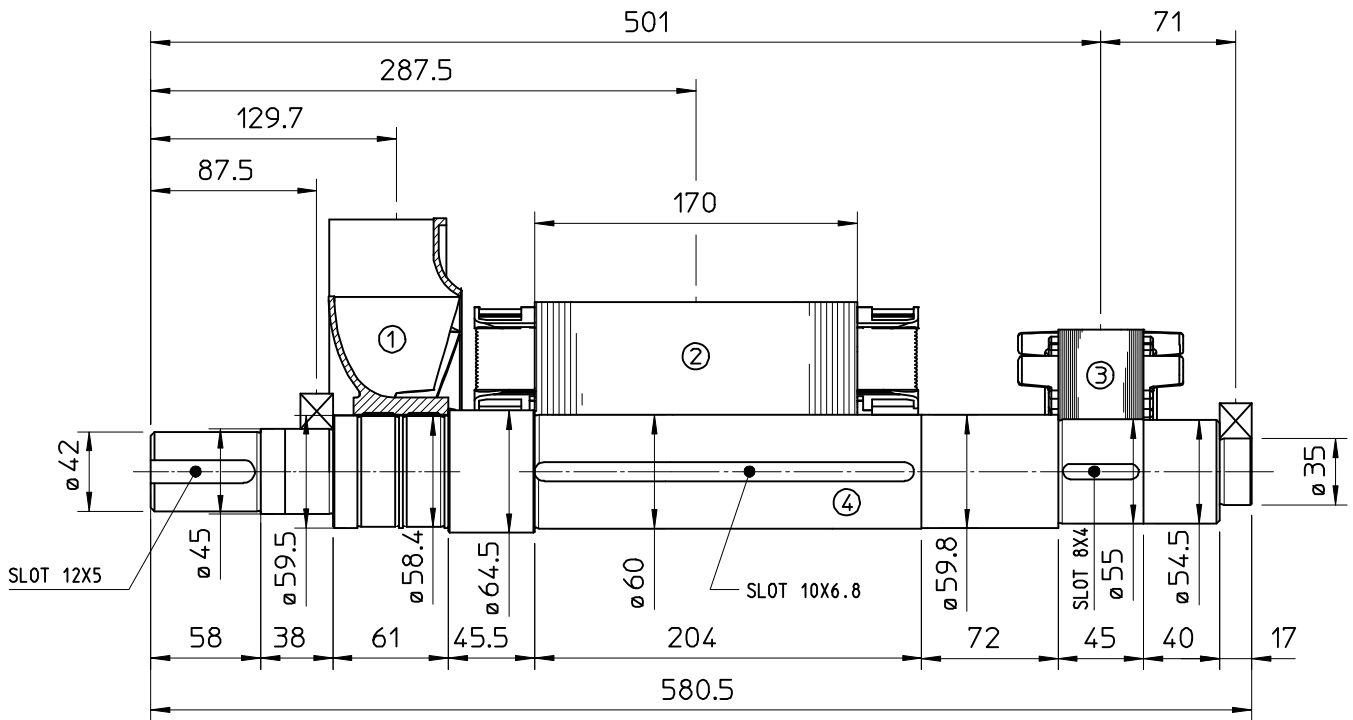

COMPONENT	WEIGHT Kg	J Kg ^m ²
1 FAN	1.2	0.0102
2 MAIN ROTOR	22.3	0.078
3 EX ROTOR	5.4	0.012
4 SHAFT	10.7	0.0045
6 TOTAL	39.6	0.1047

TWO BEARING DIMENSIONS

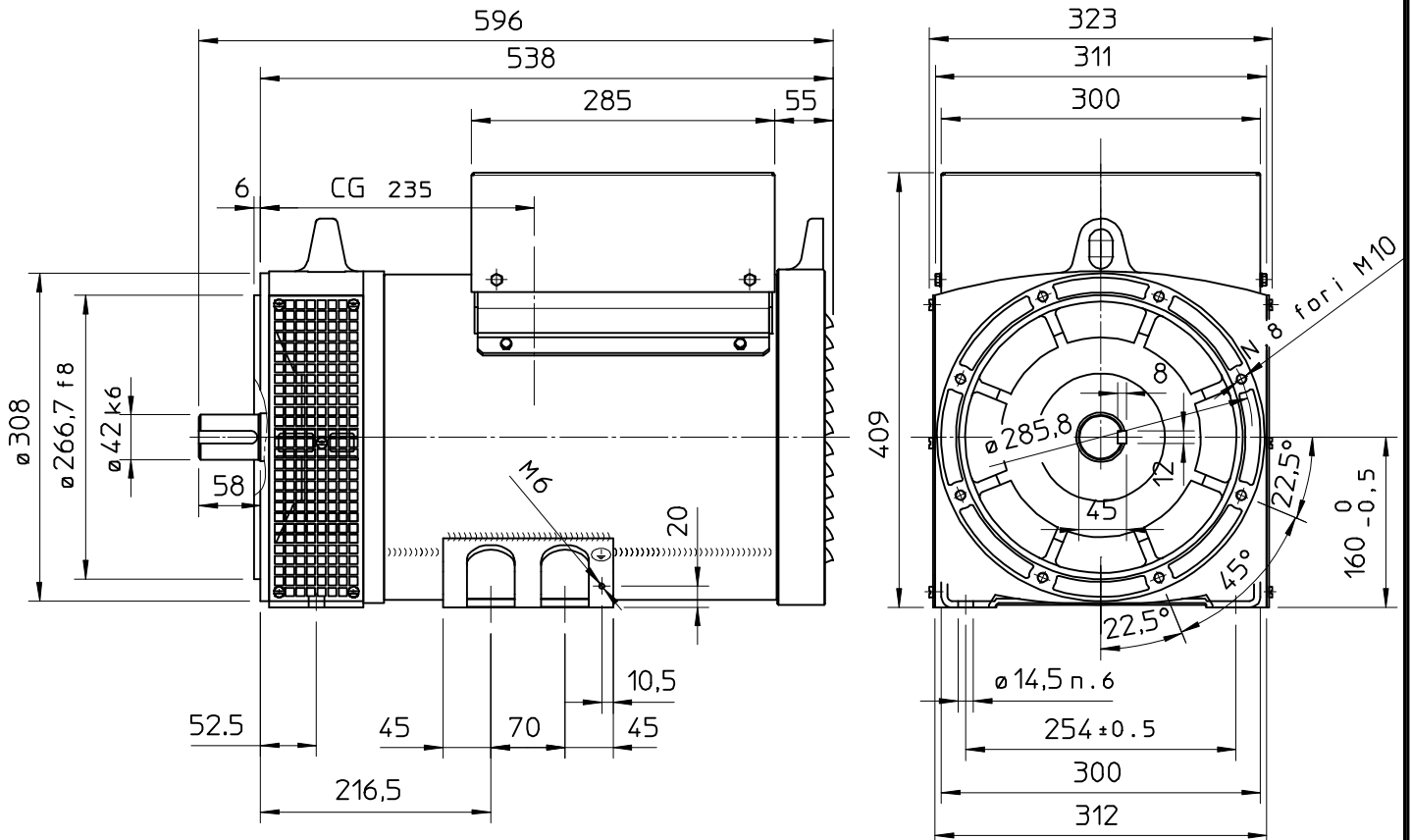

C.G. = GRAVITY CENTER

SINGLE BEARING MOMENTS OF INERTIA

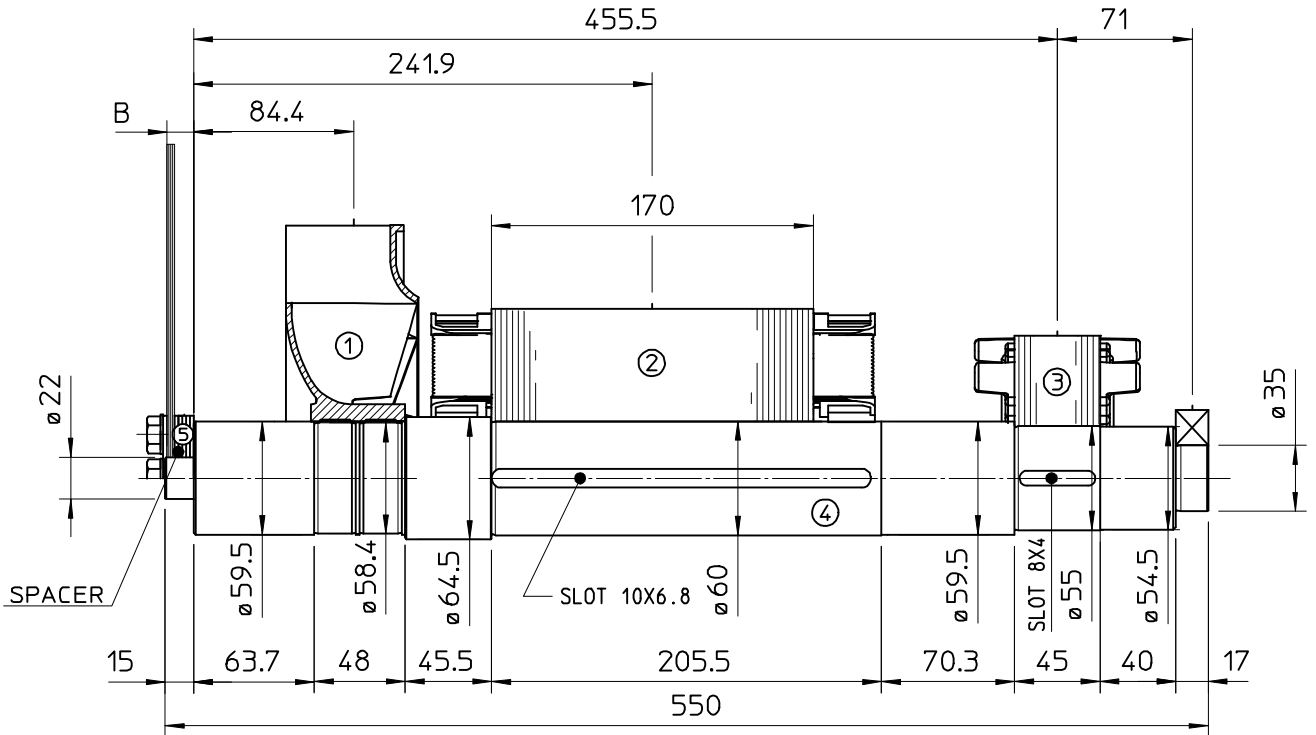

COMPONENT	WEIGHT Kg	J Kg ²
1 FAN	1.2	0.0102
2 MAIN ROTOR	22.3	0.078
3 SLIP RING	5.4	0.012
4 SHAFT	10.6	0.0044
6 TOTAL	39.5	0.1046

SAE N.	5	SHAFT COUPLING FLEX PLATE	
	B (mm)	WEIGHT kg	J kgm ²
6 1/2	4	1.14	0.0067
7 1/2	4	1.42	0.0103
8	35.6	1.97	0.0171
10	27.6	2.59	0.0319
11 1/2	14	3.1	0.0481

SINGLE BEARING DIMENSIONS

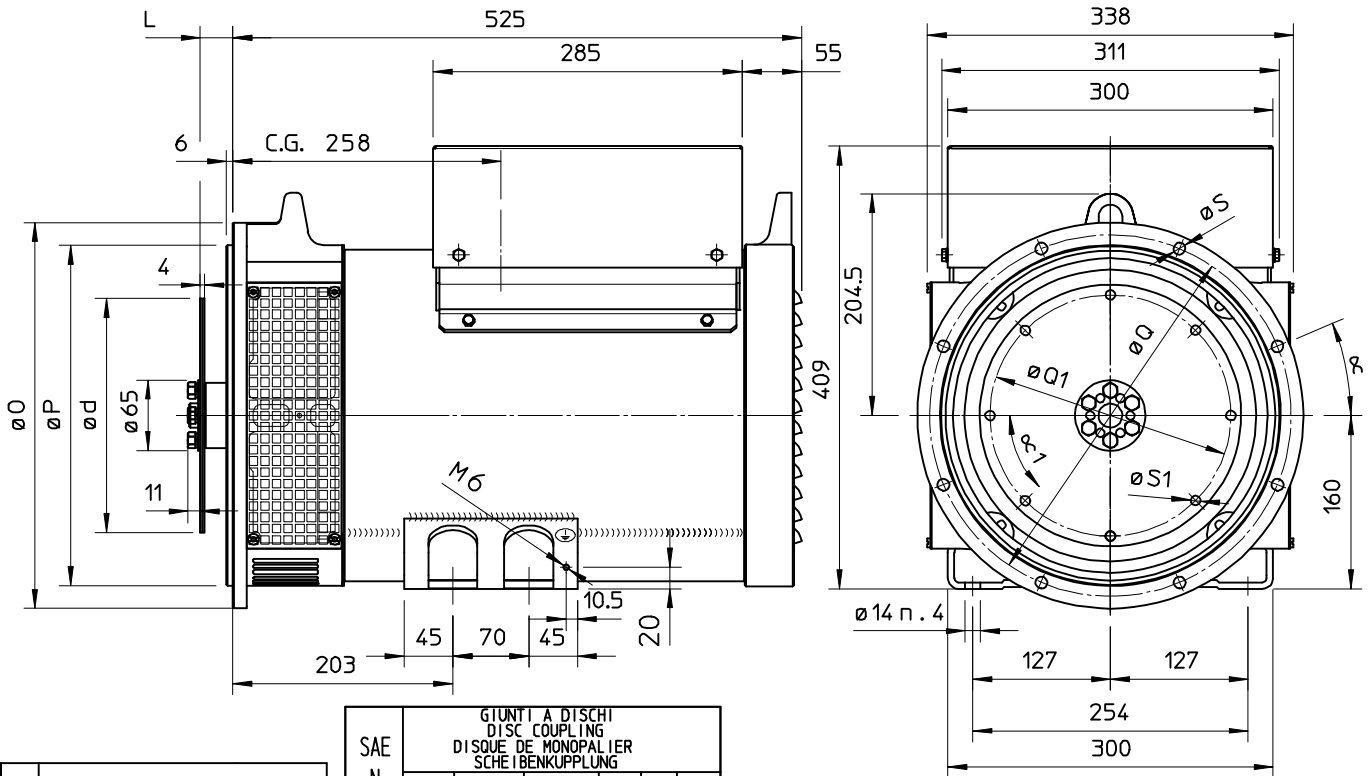

SAE N.	FLANGIA/FLANGE BRIDE/FLANSCH					
	O	P	Q	n. for i	S	α
5	356	314.3	333.4	8	11	22°30'
4	403	362	381	12	11	15°
3	451	409.6	428.6	12	11	15°

SAE N.	GIUNTI A DISCHI DISC COUPLING DISQUE DE MONOPALIER SCHEIBENKUPPLUNG					
	L	d	Q1	n. for i	S1	α1
6 1/2	30.2	215.9	200	6	9	60°
7 1/2	30.2	241.3	222.25	8	9	45°
8	62	263.52	244.47	6	11	60°
10	53.8	314.32	295.27	8	11	45°
11 1/2	39.6	352.42	333.37	8	11	45°

C.G. = GRAVITY CENTER