

Electrical Characteristics										
Frequency	Hz	50				60				
Voltage (series star)	V	380	400	415	440	415	440	460	480	
Rated power class H	kVA	35	35	35	28	41	42	42	42	
	kW	28	28	28	22,4	32,8	34	33,6	33,6	
Rated power class F	kVA	33	33	33	26	39	40	40	40	
	kW	26,4	26,4	26,4	20,8	31,2	32	32	32	
Regulation with SR7/2		±1,5 % with any power factor and speed variations between -5% +30%								
Insulation class		H								
Execution		Brushless								
Stator winding		12 ends								
Rotor		with damping cage								
Efficiencies class H	4/4	%	86,6	86,7	86,4	86,2	87,6	88,1	88,2	88,3
(see graph. for details)	3/4	%	86,5	86,8	86,7	86,4	87,8	88,2	88,2	88,4
	2/4	%	84,7	84,8	84,8	84,8	86,5	86,8	86,9	87
	1/4	%	81,7	81,5	81,3	81,2	85,1	85,3	85,4	85,5
Reactances (f. l.cl. F)	Xd	%	277,0	250	232,3	165,3	326,5	297,5	272,2	250
	Xd'	%	16,62	15	13,94	9,92	19,59	17,85	16,33	15
	Xd''	%	11,75	10,6	9,85	7,01	13,84	12,61	11,54	10,6
	Xq	%	100,8	91	84,5	60,2	118,8	108,3	99,1	91
	Xq'	%	100,8	91	84,5	60,2	118,8	108,3	99,1	91
	Xq''	%	34,3	31	28,8	20,5	40,5	36,9	33,8	31
	X ₂	%	24,38	22	20,44	14,55	28,73	26,18	23,95	22
	X ₀	%	3,10	2,8	2,60	1,85	3,66	3,33	3,05	2,8
Short Circuit Ratio	Kcc		0,60	0,70	0,86	1,38	0,40	0,50	0,60	0,70
Time Constants	Td'	sec.	0,058							
	Td''	sec.	0,012							
	Tdo'	sec.	1,35							
	Tα	sec.	0,025							
Short Circuit Current Capacity		%	>300				>350			
Excitation at no load	Amp.		0,47	0,64	0,73	1,1	0,3	0,4	0,46	0,6
Excitation at full load	Amp.		2,1	2,2	2	2,5	1,9	1,7	1,6	1,7
Overload (long-term)		%	1 hour in a 6 hours period 110% rated load							
Overload per 20 sec.		%	300							
Stator Winding Resistance (20°C)	Ω		0,097							
Rotor Winding Resistance (20°C)	Ω		2,01							
Exciter Resistance (20 °C)	Ω		Rotor : 0,64				Stator : 10,6			
Heat dissipation at f.l.cl.H	W		4333	4295	4407	3586	4643	4538	4495	4452
Telephone Interference			FHT < 2%				TIF > 45			
Radio interference			EN50081-1, EN50082-1, VDE0875K. For others standards apply to factory							
Waveform Distors.(THD) at f. load	LL/LN %		4 / 3,9							
Waveform Distors.(THD) at no load	LL/LN %		3,5 / 3,4							
Mechanical characteristics										
Protection			IP 21 (other protection on request)							
DE bearing			6312-2RS							
NDE bearing			6309-2RS							
Weight of wound stator assembly	kg		56							
Weight of wound rotor assembly	kg		38,5							
Weight of complete generator	kg		199							
Maximun overspeed	rpm		2250							
Unbalanced magnetic pull at f.l.cl.F	kN/mm		4,5							
Cooling air requirement	m ³ /min		11,8				14,5			
Inertia Constant (H)	sec.		0,113				0,136			
Noise level at 1m/7m	dB(A)		75 / 60				79 / 64			

50 Hz

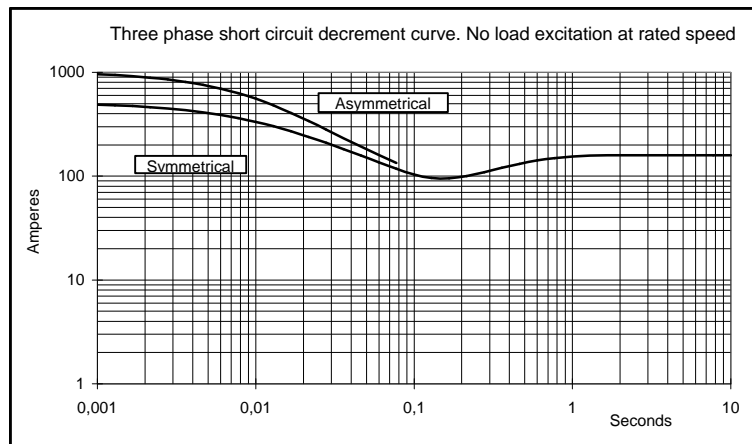

60 Hz

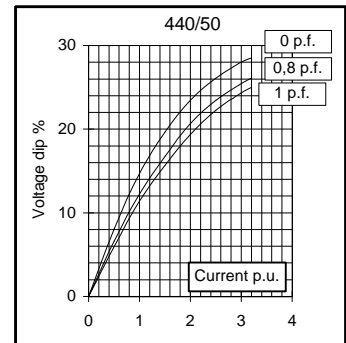
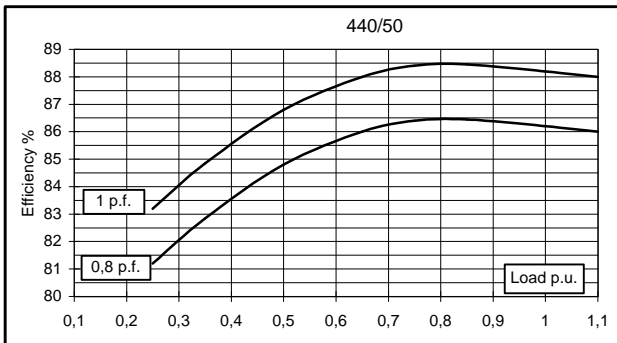
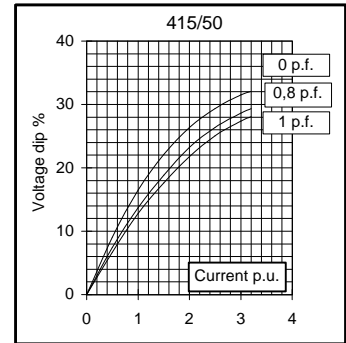
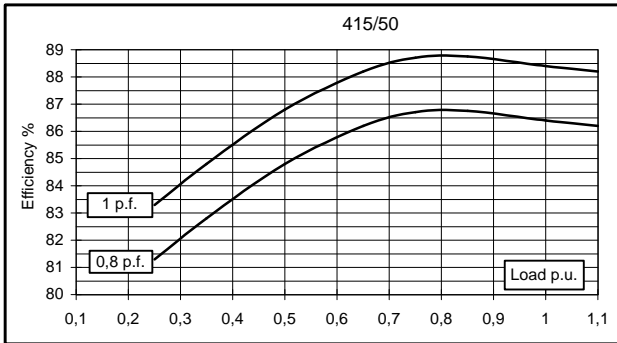
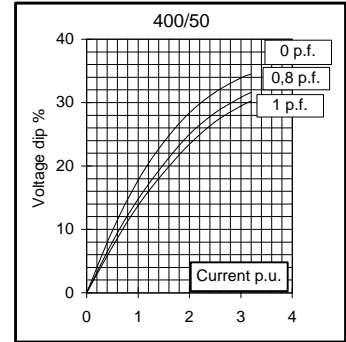
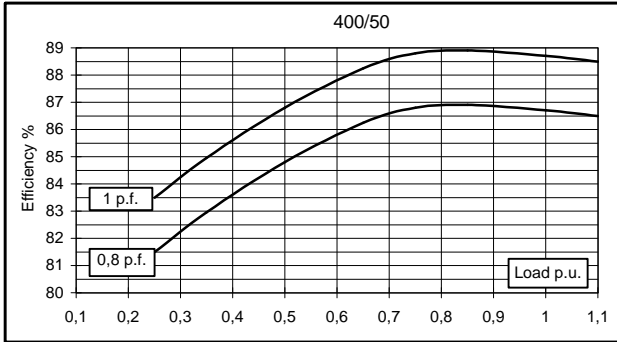
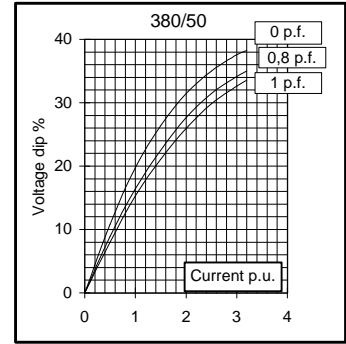
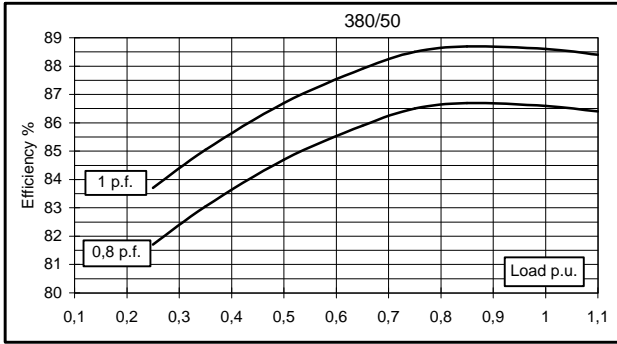
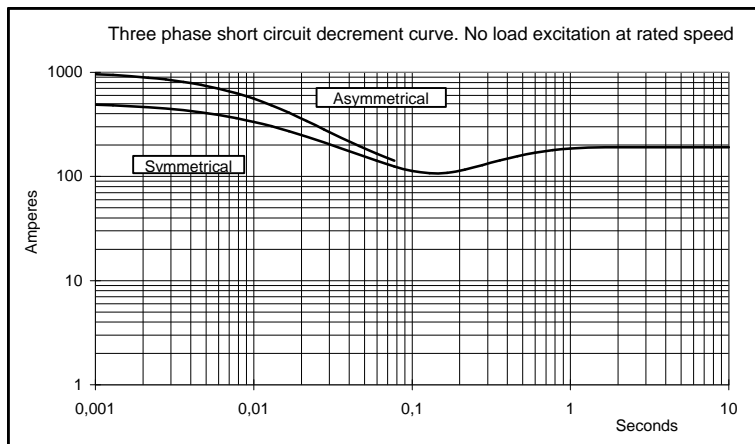
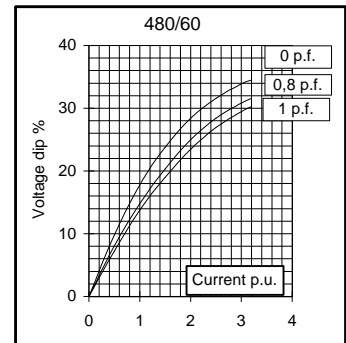
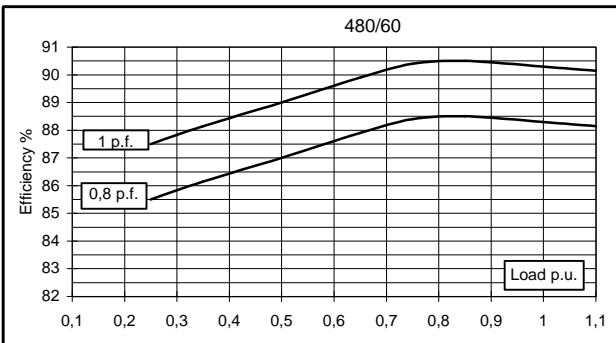
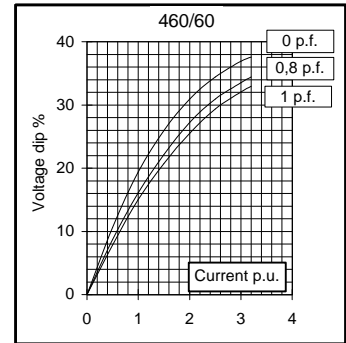
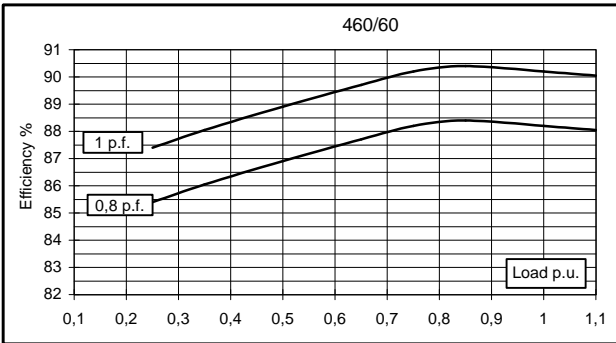
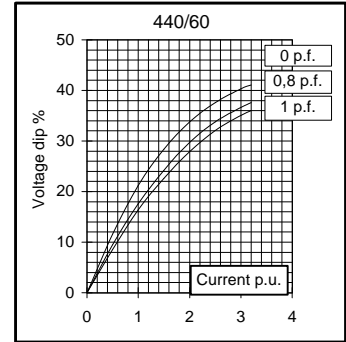
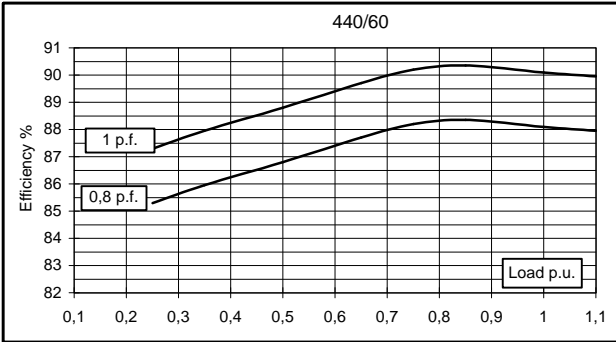
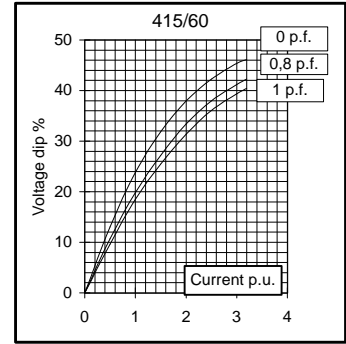
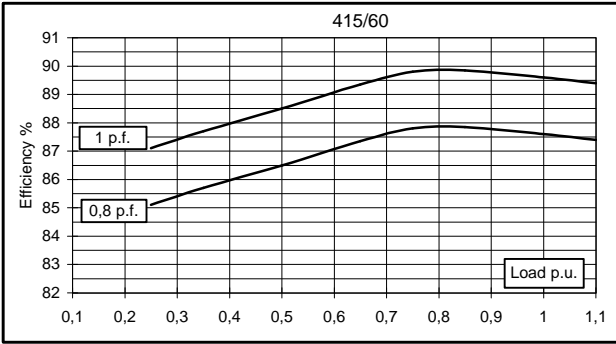

TWO BEARING MOMENTS OF INERTIA

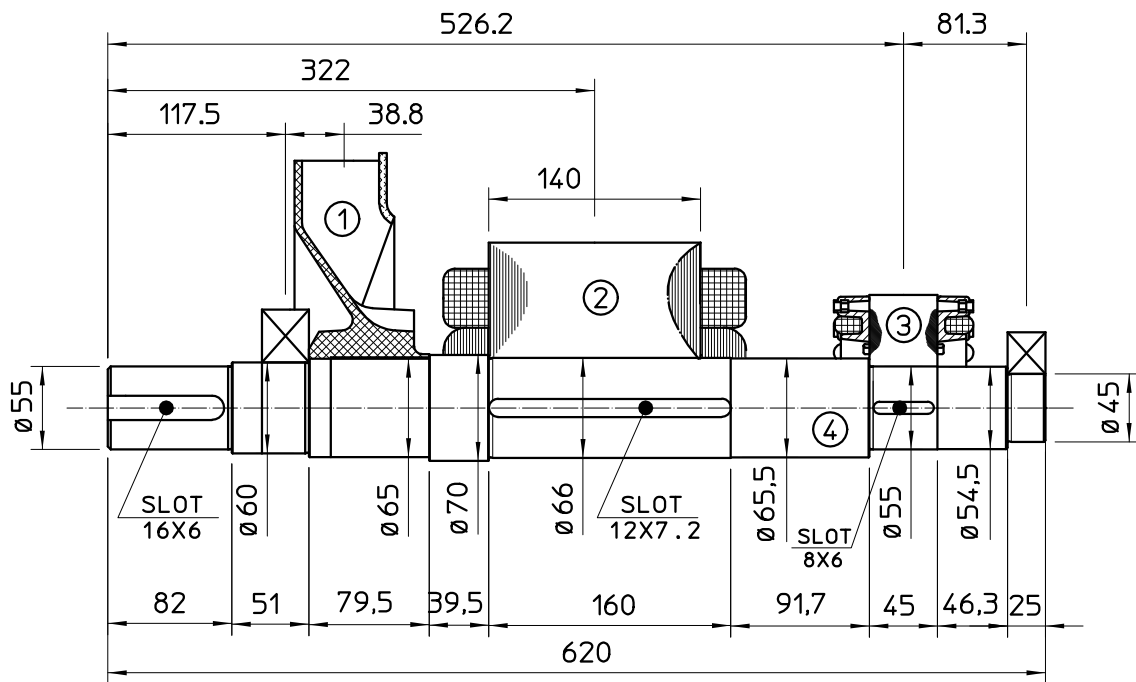

COMPONENT	WEIGHT kg	J kgm ²
1 FAN	2,3	0,0224
2 MAIN ROTOR	39,5	0,2804
3 EX. ROTOR	5,4	0,012
4 SHAFT	14,6	0,0062
TOTAL	61,8	0,3210

TWO BEARING DIMENSIONS

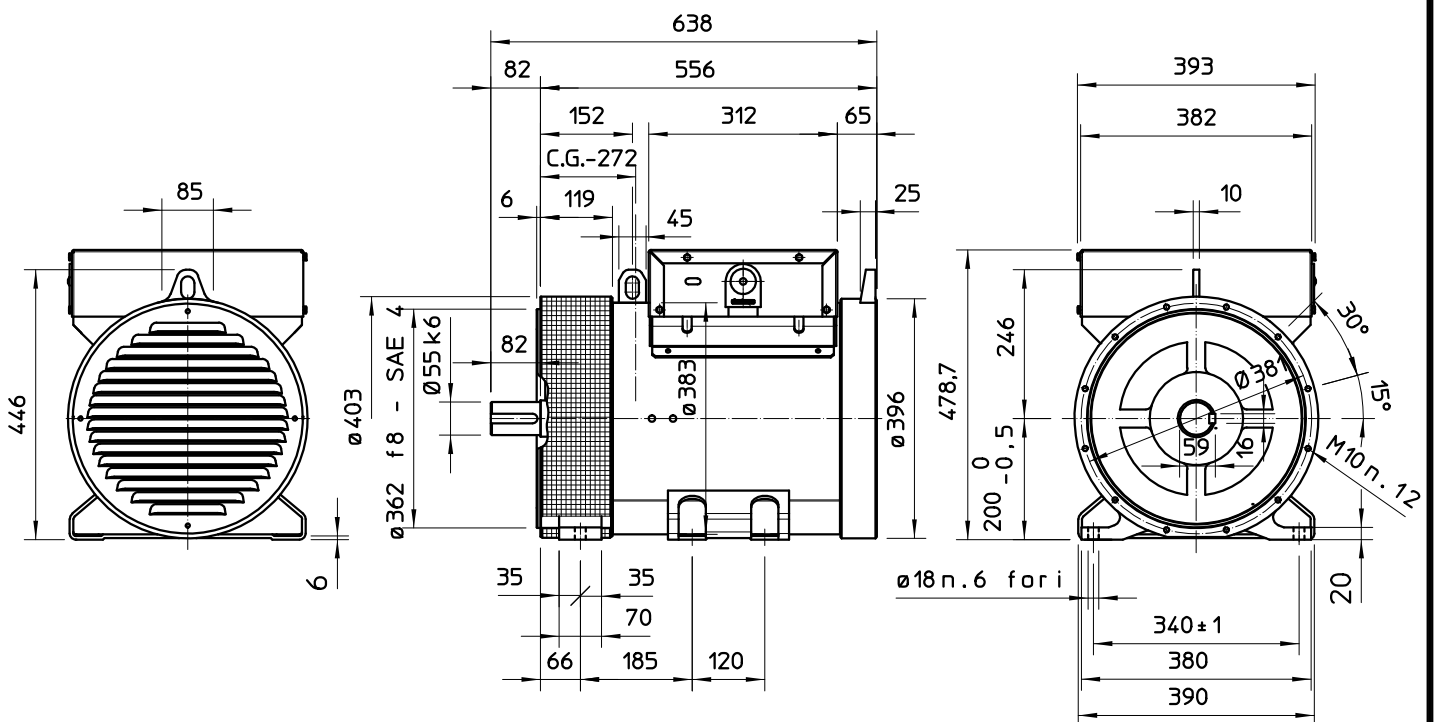

C.G. = GRAVITY CENTER

SINGLE BEARING MOMENTS OF INERTIA

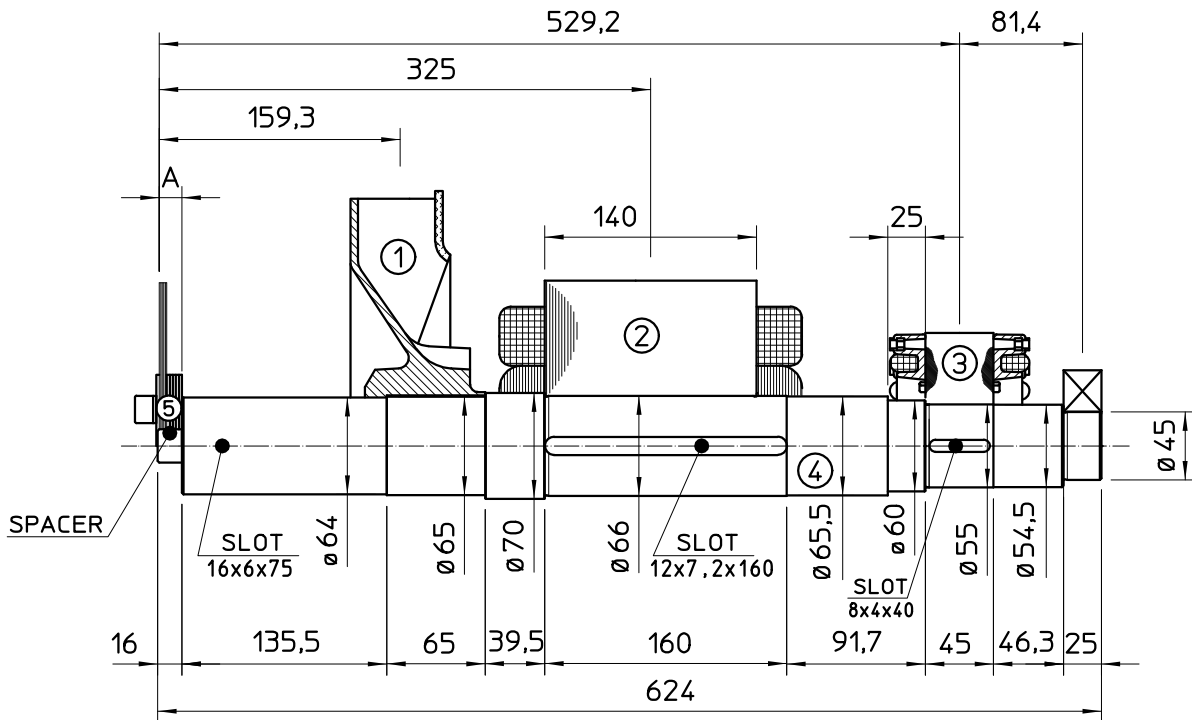

COMPONENT	WEIGHT kg	J kgm ²
1 FAN	2,3	0,0224
2 MAIN ROTOR	39,5	0,2804
3 EX. ROTOR	5,4	0,012
4 SHAFT	14,4	0,0071
TOTAL	61,6	0,3219

SAE No	SHAFTS COUPLING FLEX PLATE			
	S	A (mm)	WEIGHT kg	J kgm ²
6,5	5	1,74	0,0084	
7,5	5	2,1	0,013	
8	36,6	3,9	0,02	
10	28,6	4,47	0,038	
11,5	15	4,51	0,059	

SINGLE BEARING DIMENSIONS

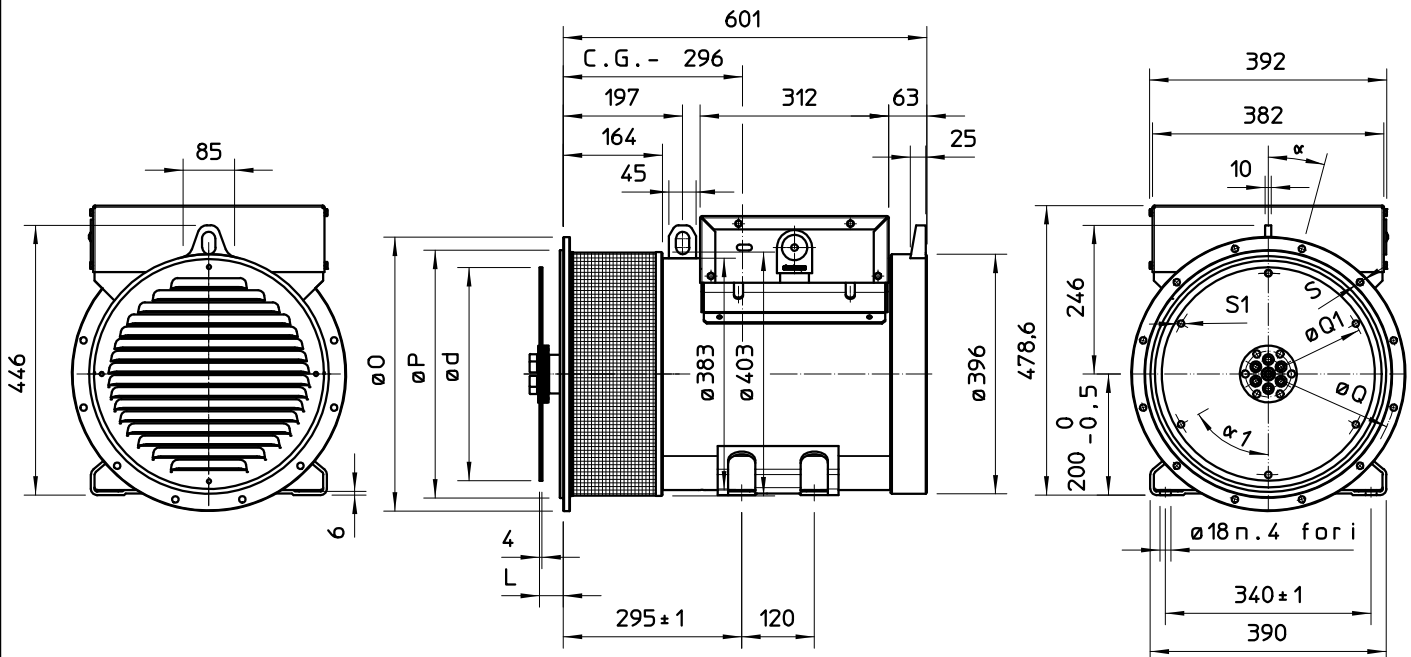

SAE No	DISC COUPLING					
	L	d	Q1	No holes	S1	a1
6,5	30,2	215,9	200	6	9	60°
7,5	30,2	241,3	222,25	8	9	45°
8	62	263,52	244,47	6	11	60°
10	53,8	314,32	295,27	8	11	45°
11,5	39,6	352,42	333,37	8	11	45°

SAE No	FLANGE					
	O	P	Q	No holes	S	a
5	356	314,3	333,4	8	11	22°30'
4	403	362	381	12	11	15°
3	451	409,6	428,6	12	11	15°
2	489	447,7	466,7	12	11	15°
1	552	511,2	530,2	12	11	15°

C.G. = GRAVITY CENTER