

<b>Electrical Characteristics</b>										
Frequency	Hz	50				60				
Voltage (star)	V	380	400	415	440	415	440	460	480	
Rated power class H	kVA	10	10	10	8,5	10,5	12	12	12	
	kW	8	8	8	6,8	8,4	9,6	9,6	9,6	
Rated power class F	kVA	9	9	9	7,5	9	10,2	10,8	10,8	
	kW	7,2	7,2	7,2	6	7,2	8,2	8,6	8,6	
Regulation with	SR7/2	±1,5 % with any power factor and speed variations between -5% +30%								
Insulation class		H								
Execution		Brushless								
Stator winding		6 ends								
Rotor		with damping cage								
Efficiencies class H	4/4	%	80,4	80,5	80,2	80	82,1	82,6	82,7	82,8
(see graph. for details)	3/4	%	80,7	81	80,9	80,6	82,6	82,8	83	83,2
	2/4	%	77,4	77,5	77,5	77,2	79,5	79,6	79,7	79,8
	1/4	%	72,1	72	71,8	71,3	72,8	72,6	72,7	73
Reactances (f. l.cl. F)	Xd	%	346,8	313	290,8	219,9	366,4	372,5	340,8	313
	Xd'	%	35,79	32,3	30,01	22,69	37,81	38,44	35,17	32,3
	Xd''	%	18,50	16,7	15,51	11,73	19,55	19,87	18,18	16,7
	Xq	%	108,0	97,5	90,6	68,5	114,1	116,0	106,2	97,5
	Xq'	%	108,0	97,5	90,6	68,5	114,1	116,0	106,2	97,5
	Xq''	%	41,7	37,6	34,9	26,4	44,0	44,7	40,9	37,6
	X <sub>2</sub>	%	20,72	18,7	17,37	13,14	21,89	22,25	20,36	18,7
	X <sub>0</sub>	%	7,53	6,8	6,32	4,78	7,96	8,09	7,40	6,8
Short Circuit Ratio	Kcc		0,36	0,48	0,69	1,31	0,23	0,31	0,36	0,48
Time Constants	Td'	sec.	0,072							
	Td''	sec.	0,012							
	Tdo'	sec.	0,63							
	Tα	sec.	0,006							
Short Circuit Current Capacity		%	>300				>320			
Excitation at no load	Amp.		0,2	0,25	0,3	0,4	0,16	0,17	0,2	0,23
Excitation at full load	Amp.		1	1,06	1,1	1,2	0,8	0,85	0,9	1
Overload (long-term)		%	1 hour in a 6 hours period 110% rated load							
Overload per 20 sec.		%	300							
Stator Winding Resistance (20°C)	Ω		1,084							
Rotor Winding Resistance (20°C)	Ω		7,364							
Exciter Resistance (20 °C)	Ω		Rotor : 1,453				Stator : 15,71			
Heat dissipation at f.l.cl.H	W		1950	1938	1975	1700	1831	2022	2008	1994
Telephone Interference			THF < 2%				TIF < 45			
Radio interference			EN50081-1, EN50082-1, VDE0875K. For others standards apply to factory							
Waveform Distors.(THD) at f. load	LL/LN %		4,8 / 4,6							
Waveform Distors.(THD) at no load	LL/LN %		4,1 / 3,9							
<b>Mechanical characteristics</b>										
Protection			IP 23 (other protection on request)							
DE bearing			6308-2RS							
NDE bearing			6305-2RS							
Weight of wound stator assembly	kg		19,4							
Weight of wound rotor assembly	kg		10,5							
Weight of complete generator	kg		63							
Maximun overspeed	rpm		4500							
Unbalanced magnetic pull at f.l.cl.F	kN/mm		2,6							
Cooling air requirement	m³/min		6,3				7,8			
Inertia Constant (H)	sec.		0,195				0,234			
Noise level at 1m/7m	dB(A)		85 / 70				89 / 73			

**50 Hz**

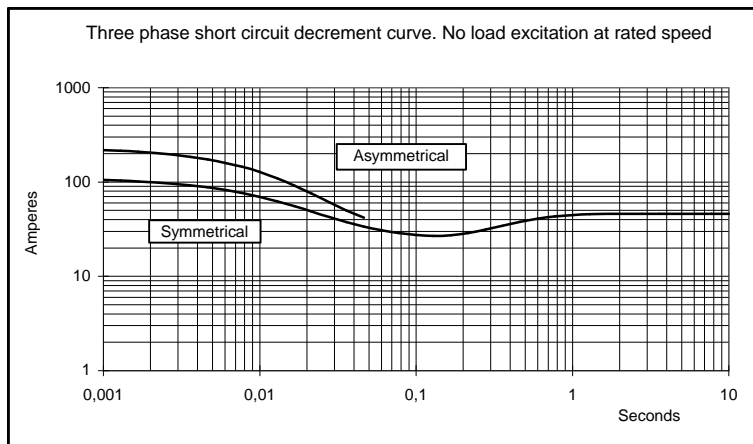

**60 Hz**

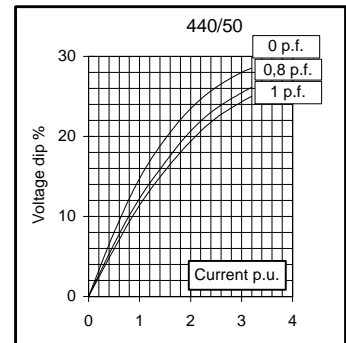
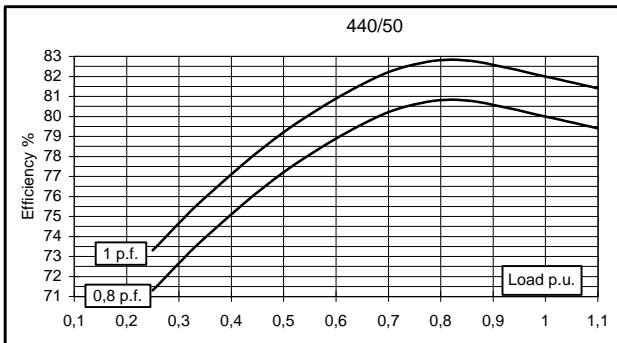
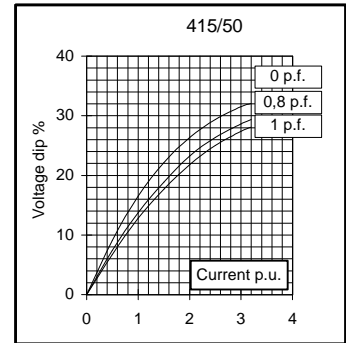
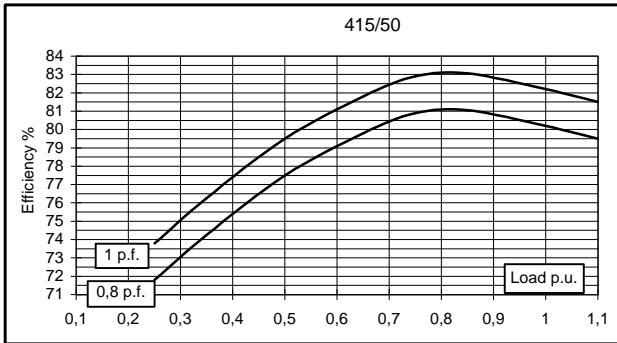
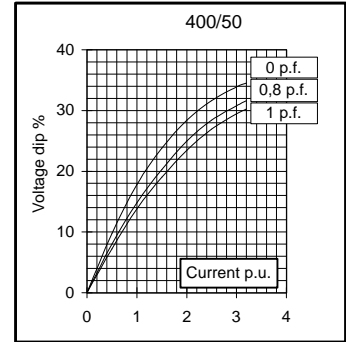
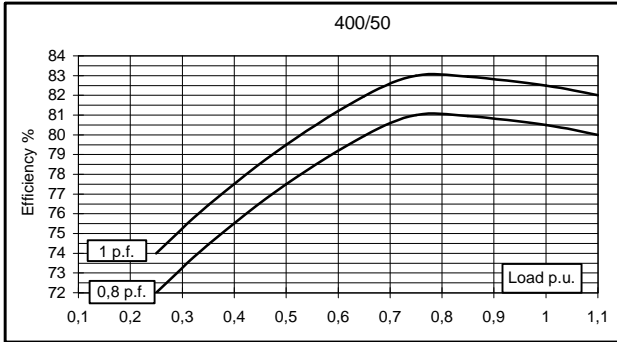
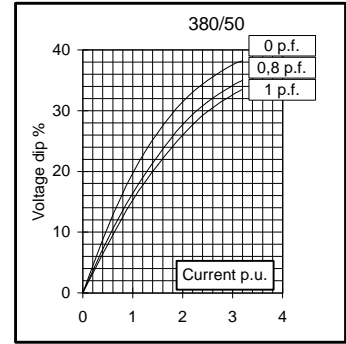
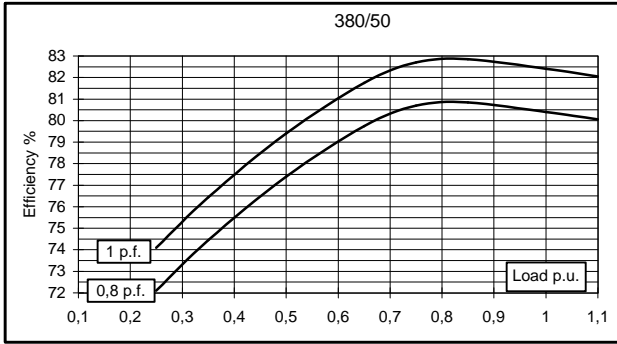
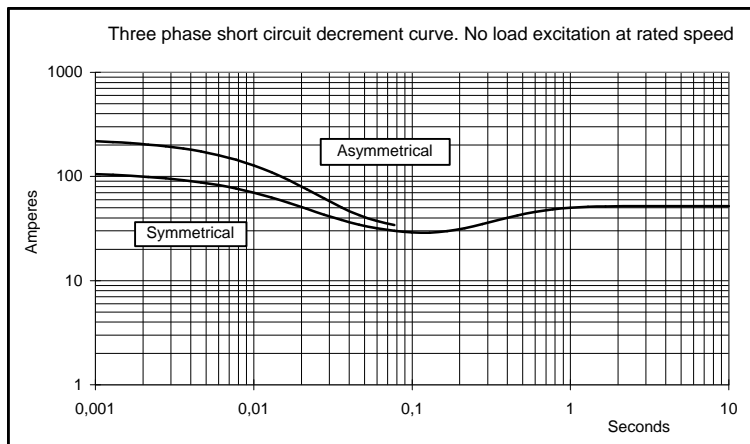
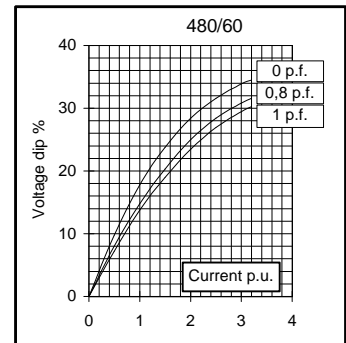
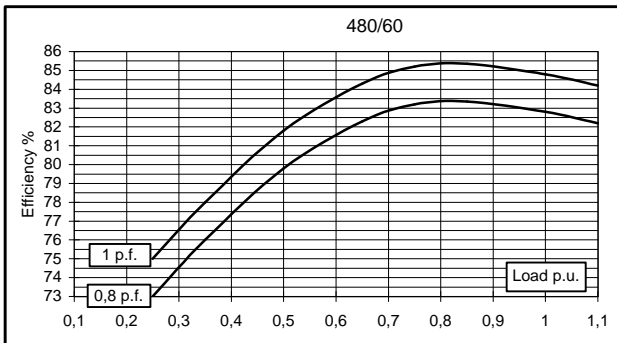
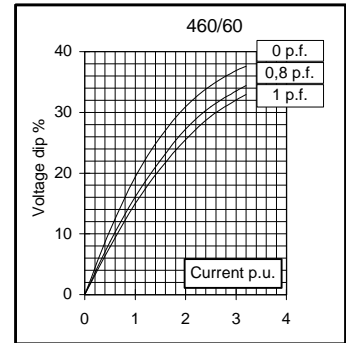
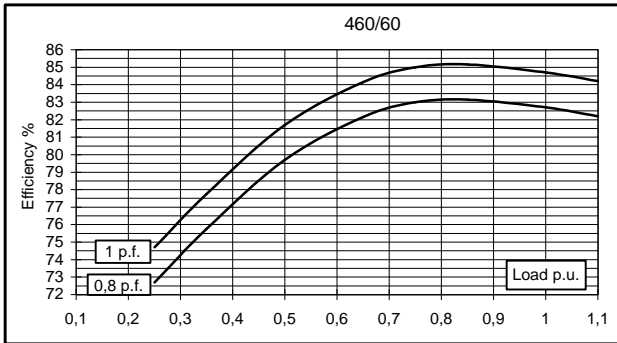
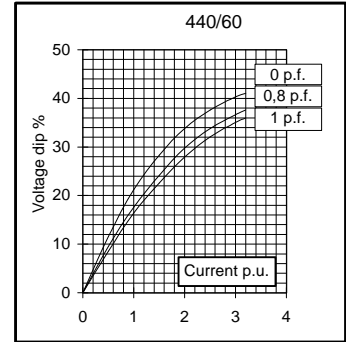
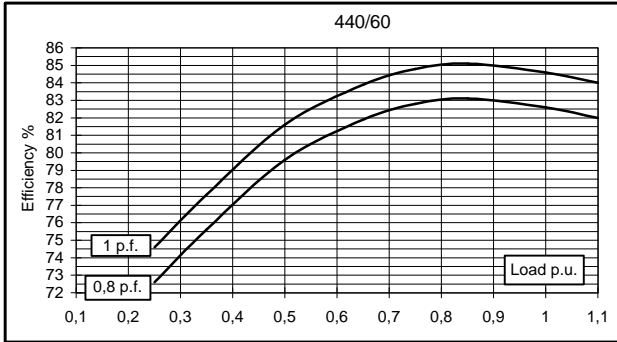
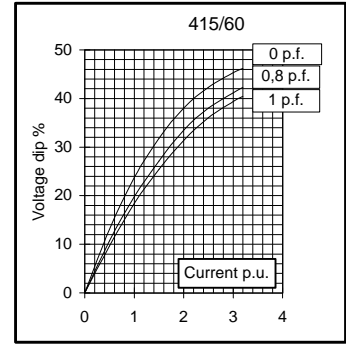
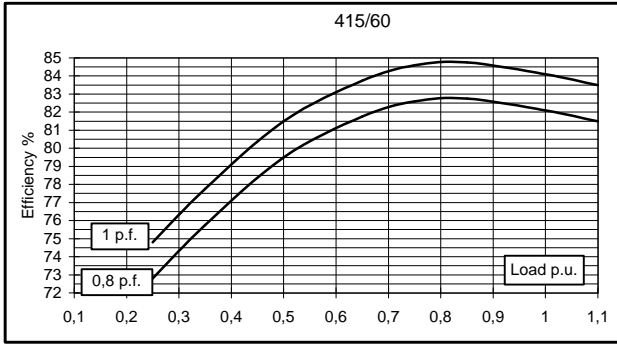

## TWO BEARING MOMENTS OF INERTIA

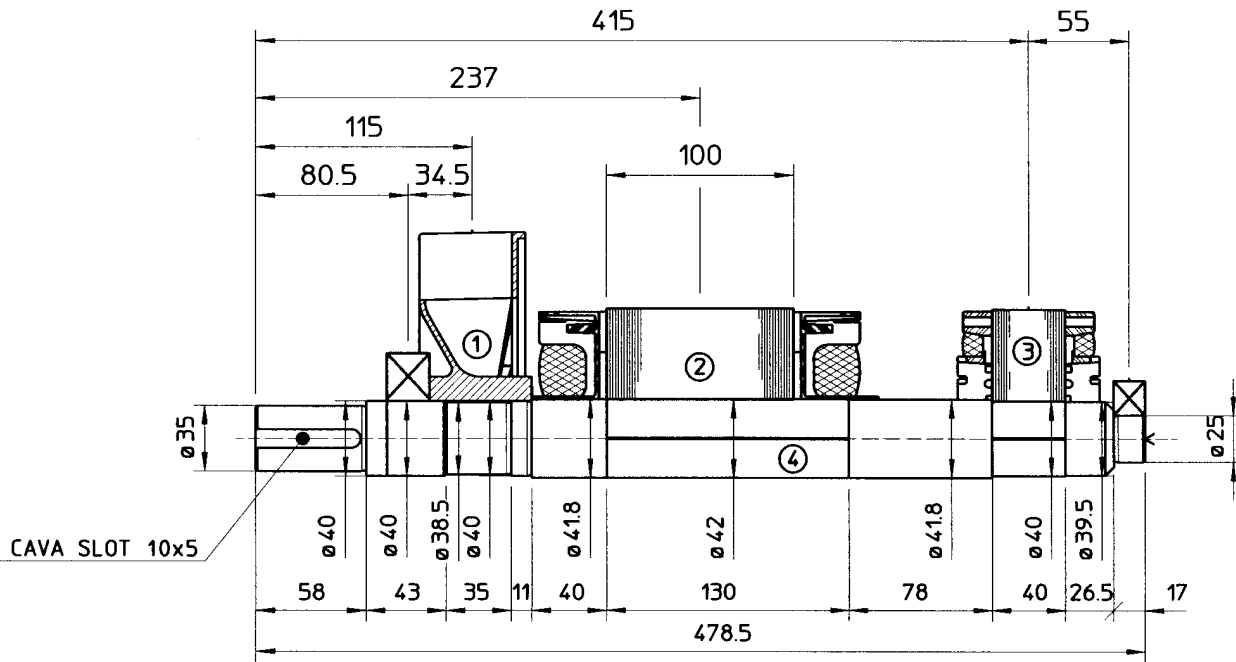

COMPONENT	WEIGHT Kg	J Kg <sup>m</sup> <sup>2</sup>
1 FAN	0.93	0.0036
2 MAIN ROTOR	10.25	0.024
3 EX ROTOR	4.12	0.011
4 SHAFT	4.7	0.00097
6 TOTAL	20	0.03957

## TWO BEARING DIMENSIONS

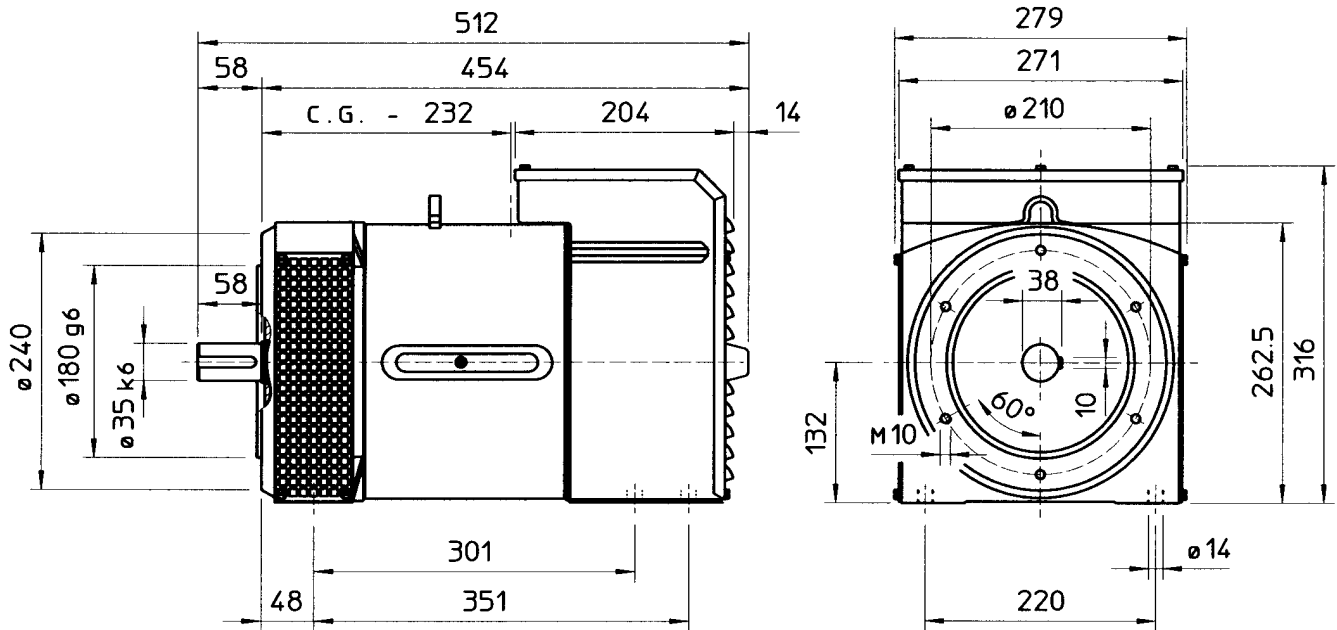

# SINGLE BEARING MOMENTS OF INERTIA

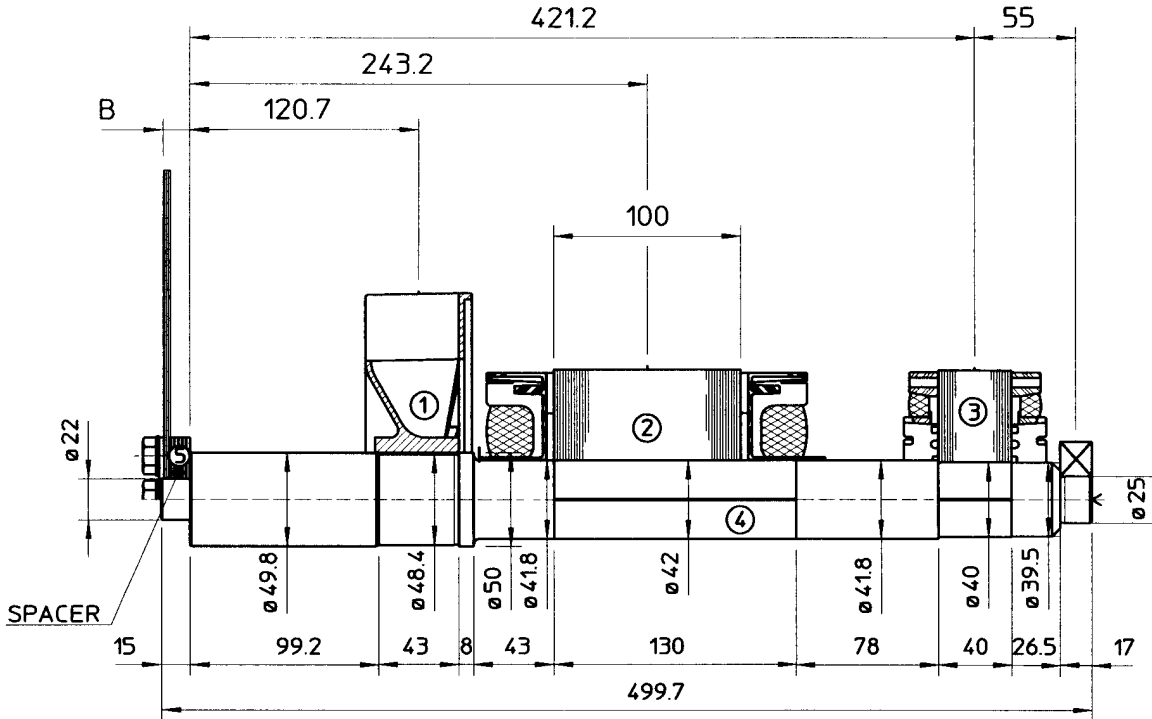

COMPONENT	WEIGHT Kg	J Kg <sup>m<sup>2</sup></sup>
1 FAN	0.82	0.0032
2 MAIN ROTOR	10.25	0.024
3 EX ROTOR	4.12	0.011
4 SHAFT	5.6	0.0012
6 TOTAL	20.79	0.0394

SAE N.	5 B (mm)	SHAFT COUPLING FLEX PLATE WEIGHT kg	J kg <sup>m<sup>2</sup></sup>
6 1/2	4	1.14	0.0067
7 1/2	4	1.42	0.0103
8	35.6	1.97	0.0171
10	27.6	2.59	0.0319
11 1/2	14	3.1	0.0481

# SINGLE BEARING DIMENSIONS

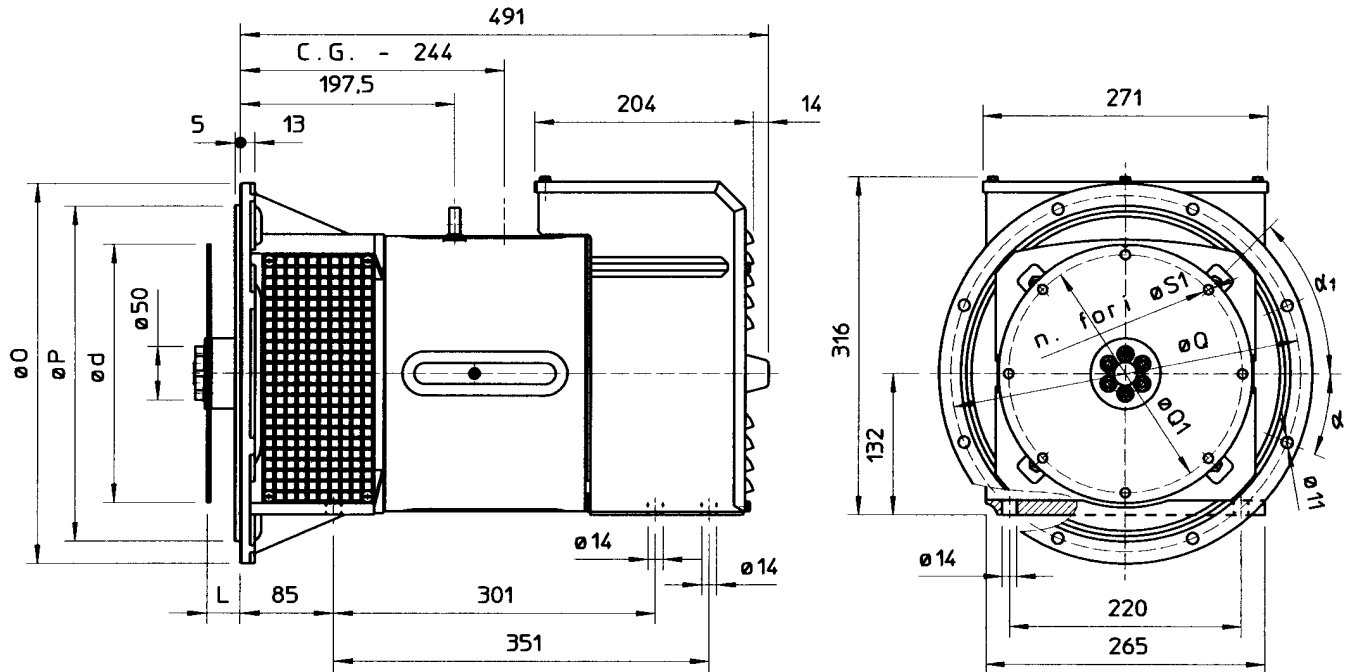

## GIUNTI A DISCO COUPLING DISC PLATEX DISQUE DE MONPALIER SCHEIBENKUPPLUNG JUNTAS A DISCOS

SAE N.	L	d	Q1	n. fori	S1	$\alpha_1$
6 1/2	30.2	215.9	200	6	9	60°
7 1/2	30.2	241.3	222.25	8	9	45°
8	62	263.52	244.47	6	11	60°
10	53.8	314.32	295.27	8	11	45°
11 1/2	39.6	352.42	333.37	8	11	45°

FLANGIA FLANGE BRIDE FLANSCH BRIDAS	SAE N.	O	P	Q	n. fori	$\alpha$
	6	308	266.7	285.75	8	22°30'
	5	356	314.3	333.4	8	22°30'
	4	403	362	381	12	15°
	3	451	409.6	428.6	12	15°

C.G. - GRAVITY CENTER